

**Thule Touring**

# ➤ **Instructions**

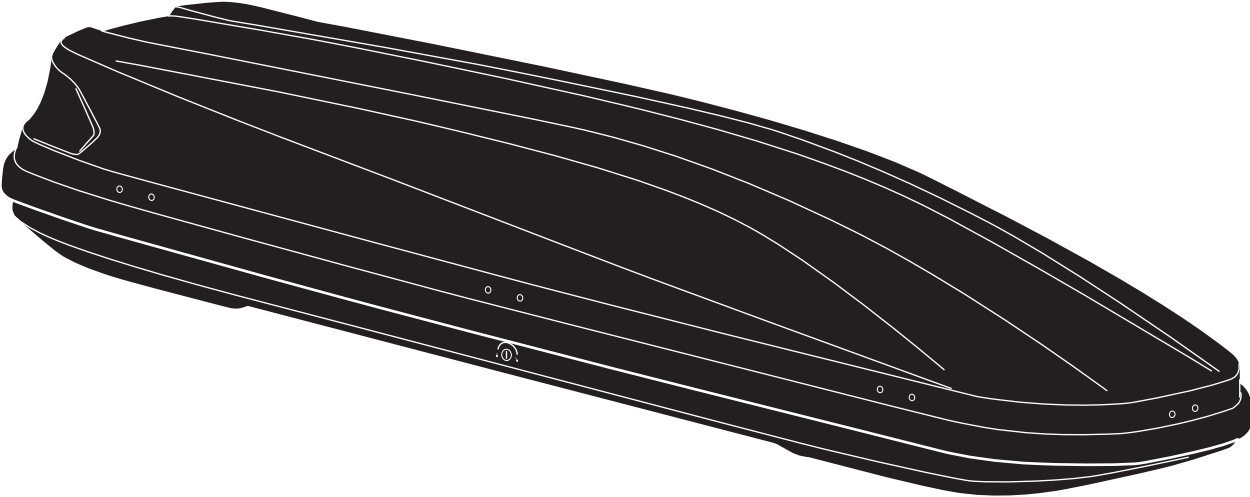

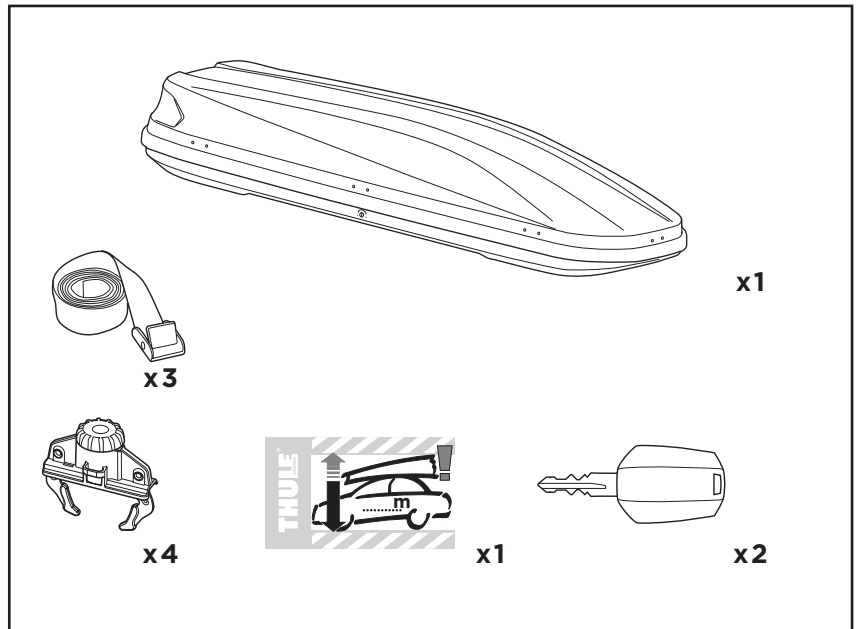
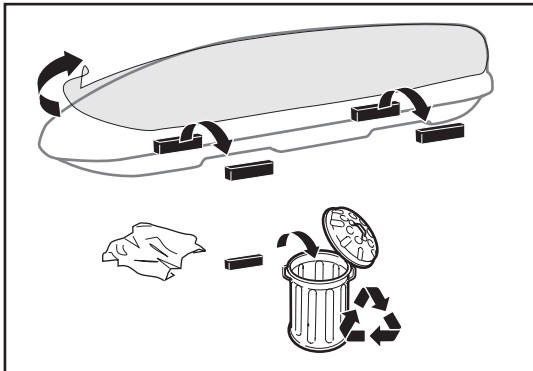
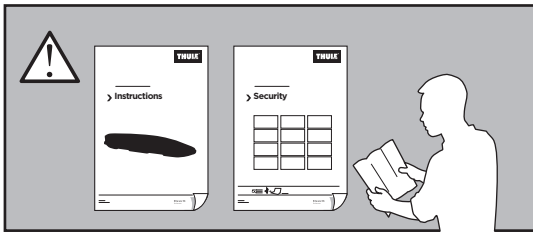

**1**

**i** Thule T-track adapter

**696400**

**697400**

Diagram showing the installation of the T-track adapter on a car roof. The adapter is shown being inserted into the T-track. The diagram also shows the adapter being secured with a bolt and nut.

Touring 100  
**Min 515 mm**  
**Max 925 mm**

Touring 200, 600, 700, 780  
**Min 545 mm**  
**Max 955 mm**

Max 90 mm  
 Min 18 mm  
 Max 38 mm

Max 90 mm  
 Min 18 mm  
 Max 38 mm

**2**

Diagram showing the installation of the surfboard rack on a car roof. The rack is shown being placed on the roof rails. The diagram also shows the rack being secured with a lock and key.

3

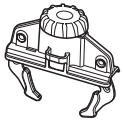

x4

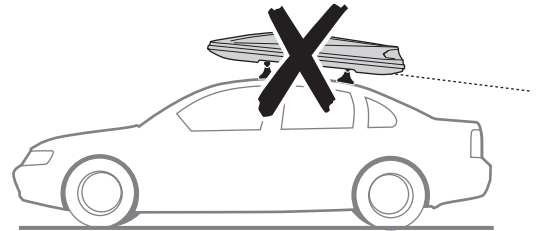
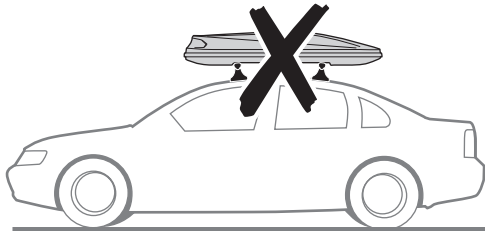
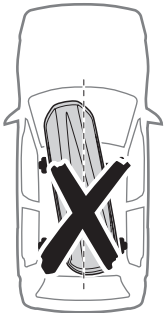
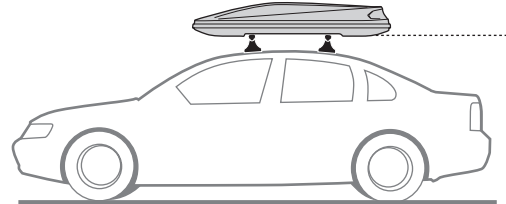
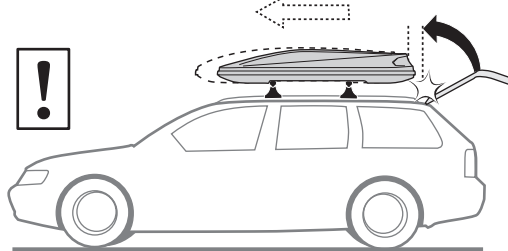
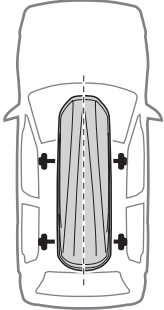
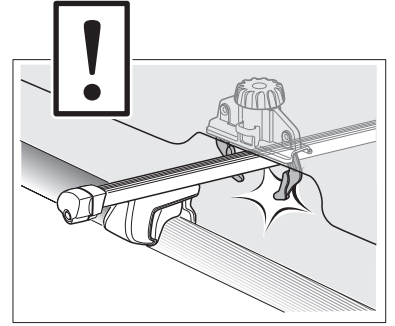
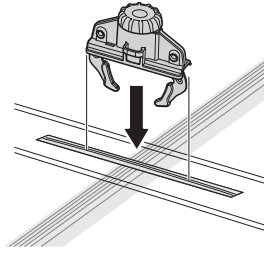
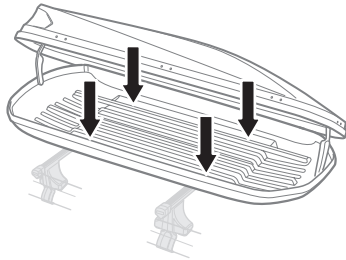

4

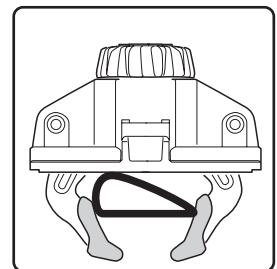
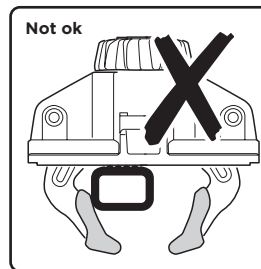
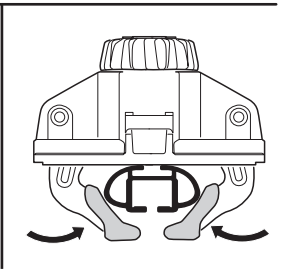
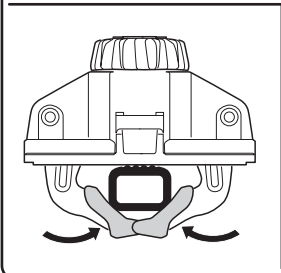
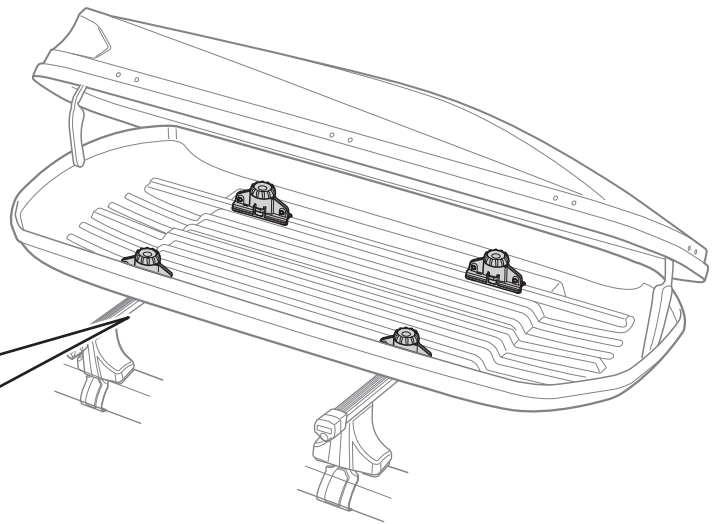
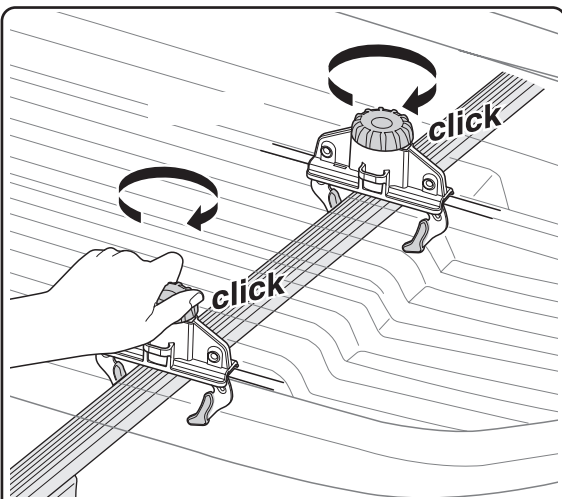

5

Touring 100

Touring 200  
Touring 600  
Touring 700  
Touring 780



x3

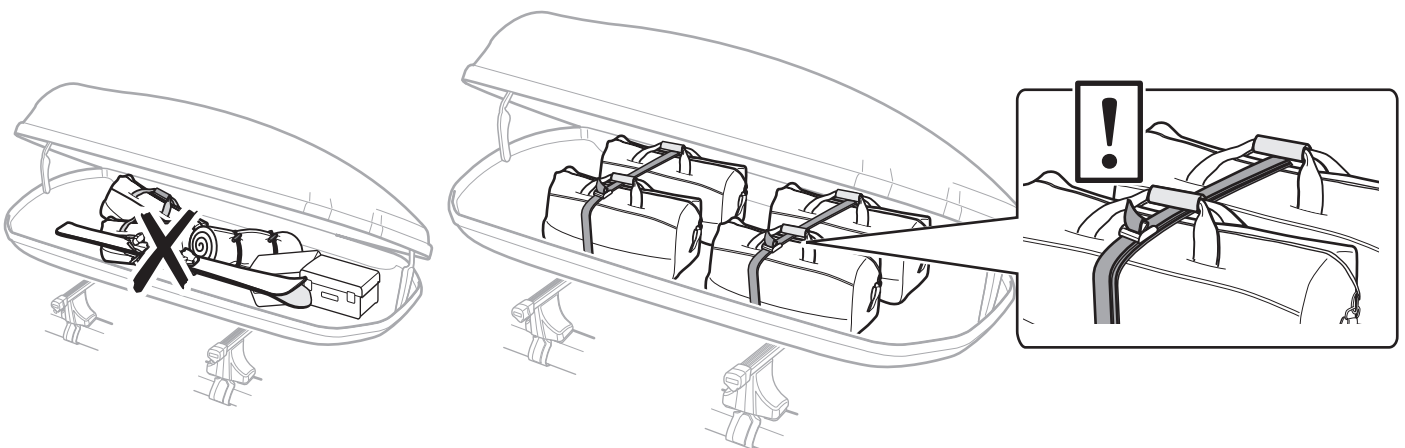
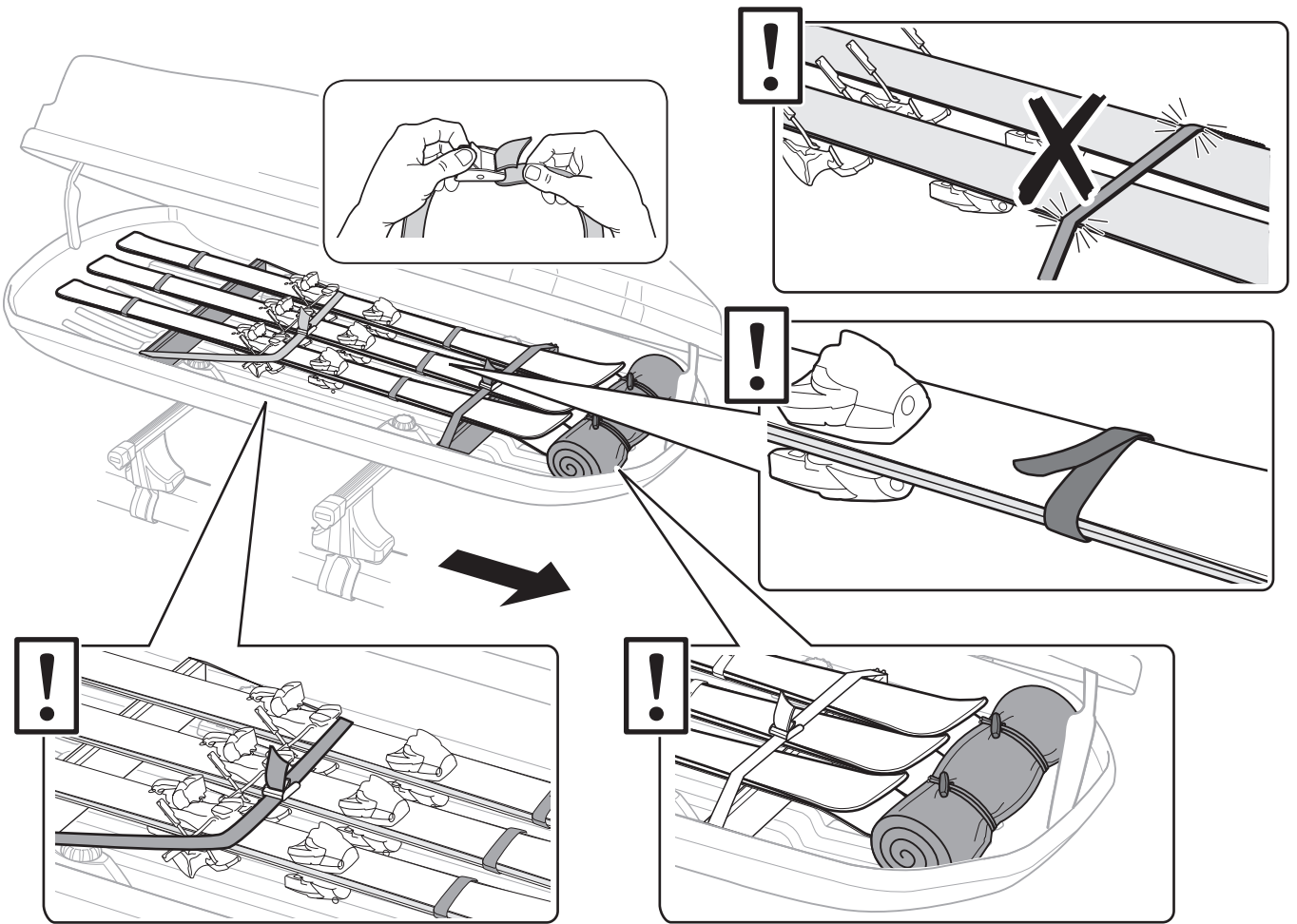
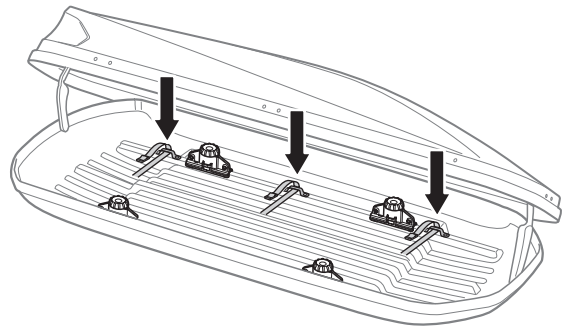
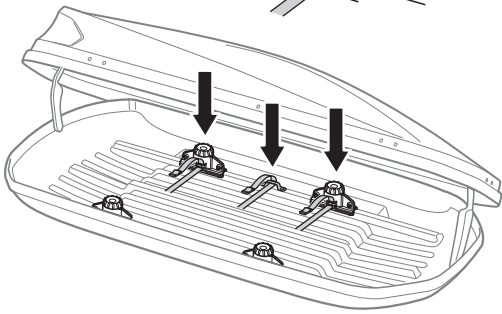
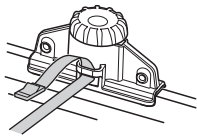

6

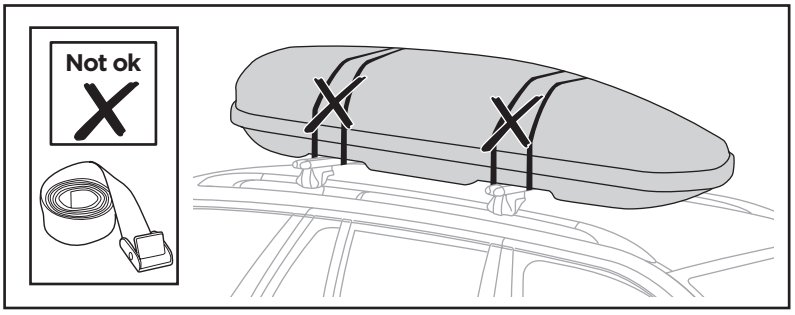
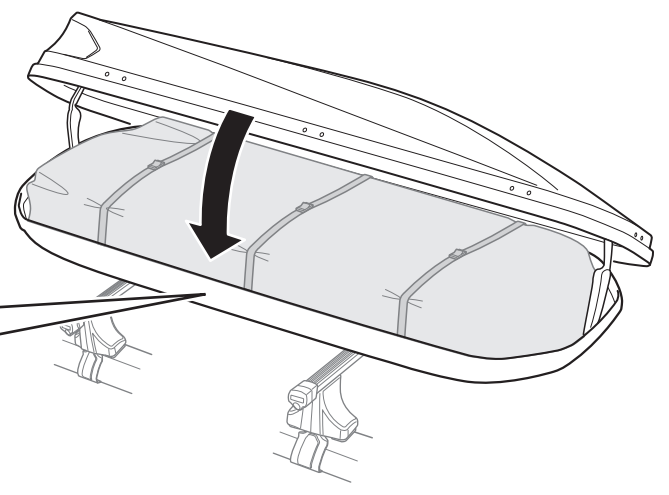
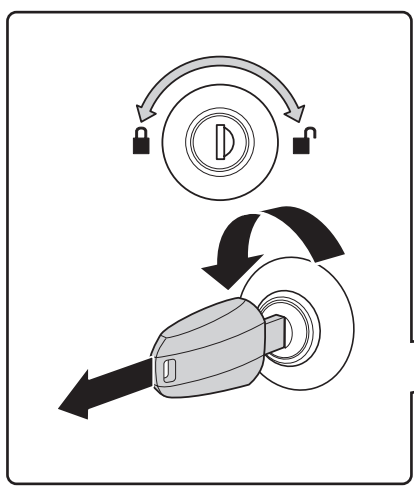

7

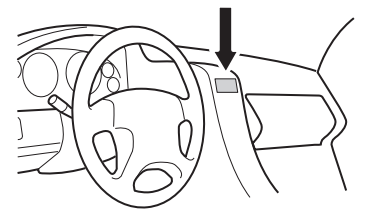
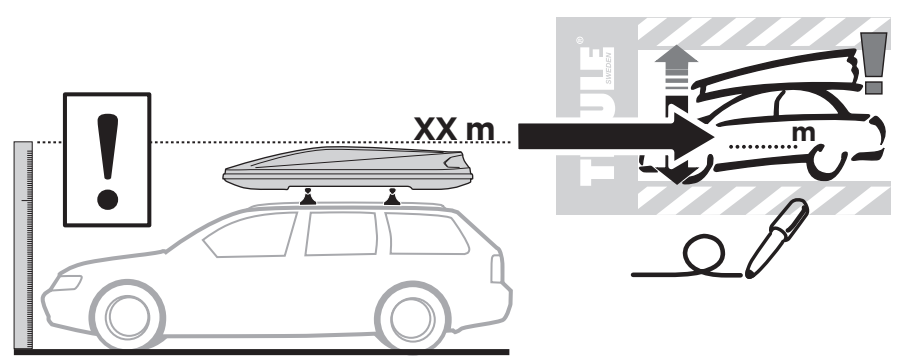
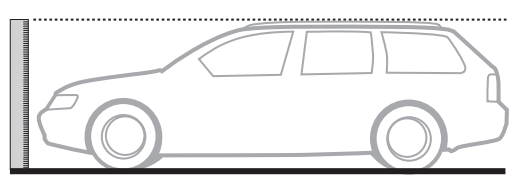
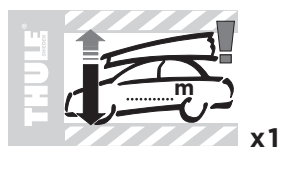

**i** Thule T-track adapter

**696400** → 24x30 mm

**697400** → 20x27 mm

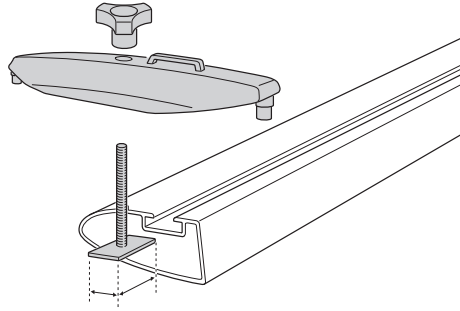

**i** Thule Boxlift

**571000**

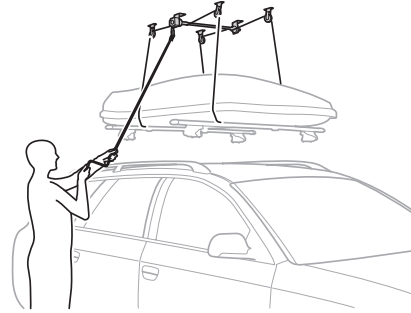
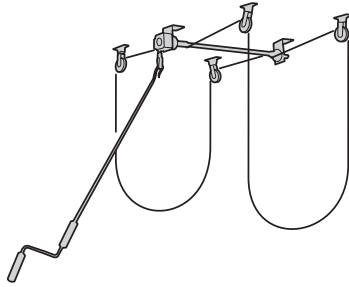

**i** Thule Box Ski Carrier adapter

**694800** → Touring: 200, 780

**694600** → Touring: 600

**694700** → Touring: 700

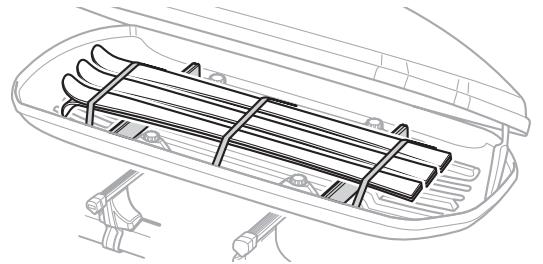
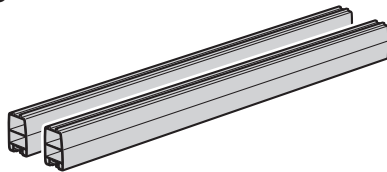

**i** Thule Box light

**695100**

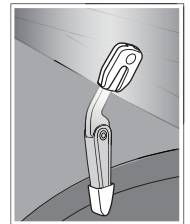
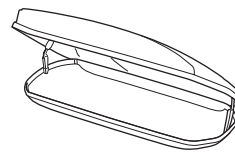
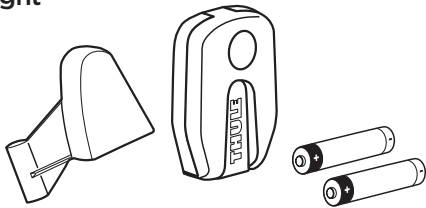

**i** Thule Lid protection cover

**698100** → Touring: 100, 200, 780

**698200** → Touring: 600, 700

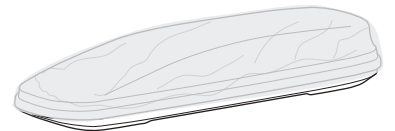
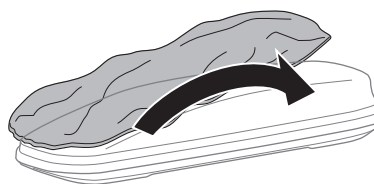

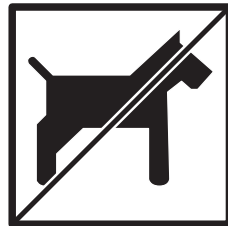
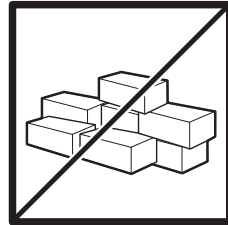
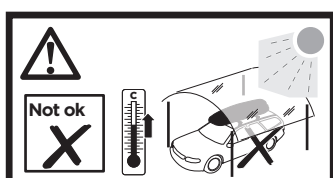
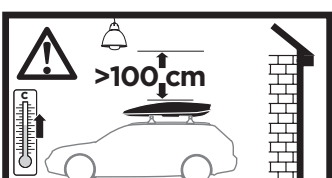
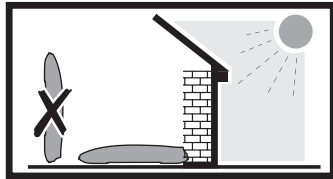
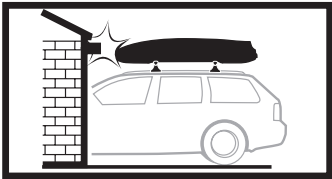
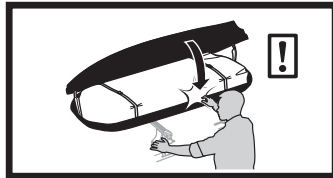
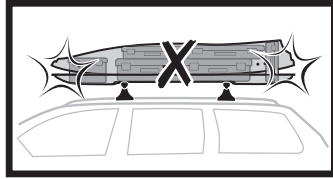
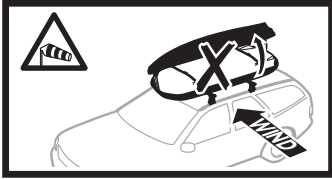
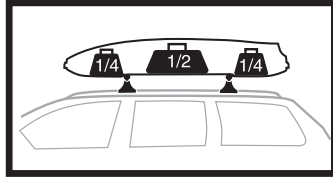
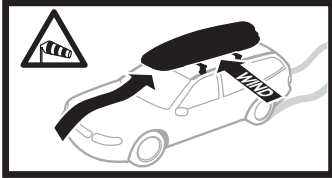
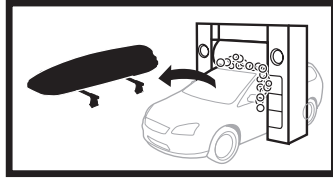
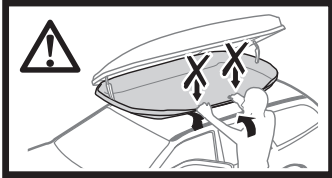



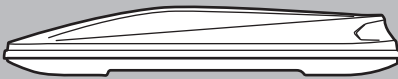

**Touring 100: 10 kg**  
**Touring 200: 13 kg**  
**Touring 600: 12 kg**  
**Touring 700: 15 kg**  
**Touring 780: 15 kg**

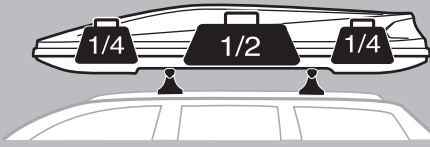



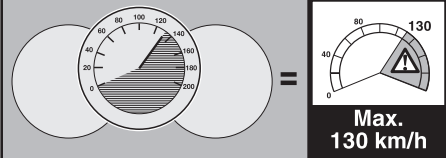

**Max 50 kg**

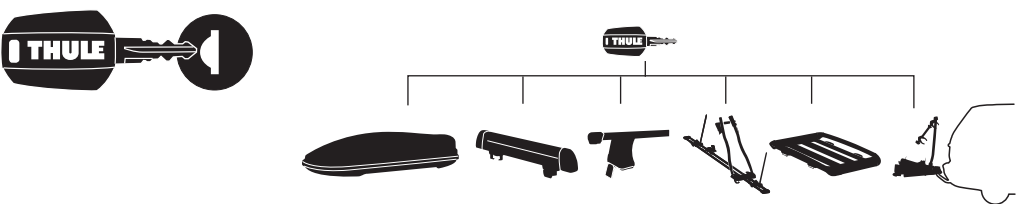

**Max. 130 km/h**

## Thule One-Key System

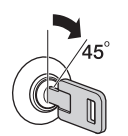
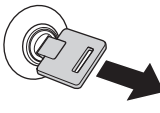
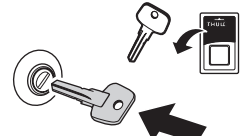
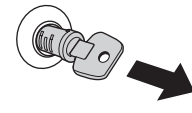
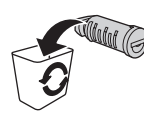
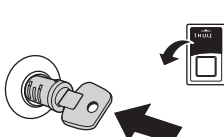
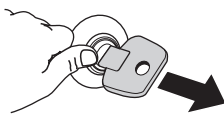

- 544**  (x4)
- 596**  (x6)
- 588**  (x8)
- 452**  (x12)

- 1** 
- 2** 
- 3** 
- 4** 
- 5** 
- 6** 
- 7** 
- 8** 