

THULE RACK GUIDELINES

When using Thule Load Carriers and accessories, the user must understand the precautions. The points listed below will assist you in using the rack system and will encourage safety.

Please review the instructions and warranty carefully. Assembly and installation are the end user's responsibility and beyond Thule's control. Therefore, Thule exclusively limits its warranty to the repair or replacement of a defective Thule product for up to three (3) years from the date of the original retail purchase. All Car Top Boxes are warranted for a period of two (2) years. Damage to your vehicle, cargo, or to any person or property is excluded.

- For quality fits and safety, use only the recommended rack or accessory as stated in Thule's current Fit Guide. Do not assume a rack will fit, always check the current Fit Guide when obtaining a new vehicle. Use only Thule accessories on Thule Load Carriers. Using other brands will void your warranty.
- Do not carry more than 75 kg (165 lbs.) on Thule Load Carriers. Thule Load Carriers do not increase gutter or roof strength. Thule can not warranty loads that exceed this limit. Total load equals cargo weight plus weight of accessories used to carry cargo.
- Always make sure car doors are open when mounting a roof rack system. Make sure all knobs, bolts, screws, straps, and locks are firmly attached, tightened and locked before every trip. Knobs, bolts, screws, straps, and locks must be periodically inspected for signs of wear, corrosion, and fatigue. Check your load at stops during the trip to ensure continued fastening security.
- Check local and state laws governing projection of objects beyond the width of a vehicle. Be aware of the width and height of your cargo since low clearance branches, bridges, and parking garages can affect the load. All cargo will affect the vehicle's driving behavior. Never drive with any lock, knob or rack in an open or unlocked position. All long loads such as, but not limited to, sailboards, surfboards, kayaks, canoes, and lumber must be tied down front and rear to the bumpers or tow hooks of the vehicle.
- Remove your Thule rack and accessories when they are not in use and before entering automatic car washes. Do not attach Thule rack to vinyl tops, T-tops or fiberglass tops or to vehicles not listed in the current Fit Guide.
- All locks must be turned and moved periodically to ensure smooth operation. Use graphite or dry lubricant to help this. Thule locks are designed to deter vandalism and theft. Remove valuable gear if your vehicle is unattended for an extended period. Place at least one key in the glove compartment. Replacement keys are available only through your Thule dealer.
- For safety to your vehicle and rack system, obey all posted speed limits and traffic cautions. Adapt your speed to the conditions of the road and the load being carried.
- Do not use Thule load carriers and accessories for purposes other than those for which they were designed. Do not exceed their carrying capacity. Failure to follow these guidelines or the product's instructions will void the warranty.
- Consult with your Thule dealer if you have any questions regarding the operations and limits of Thule products. Review all instructions and warranty information carefully.

THULE U.S.A.
42 SILVERMINE RD.
SEYMOUR, CT 06483

501-5256

558P PIVOTING TANDEM CARRIER



558P

THULE[®]
SWEDEN
CAR RACK SYSTEMS

MADE IN U.S.A.

PARTS INCLUDED

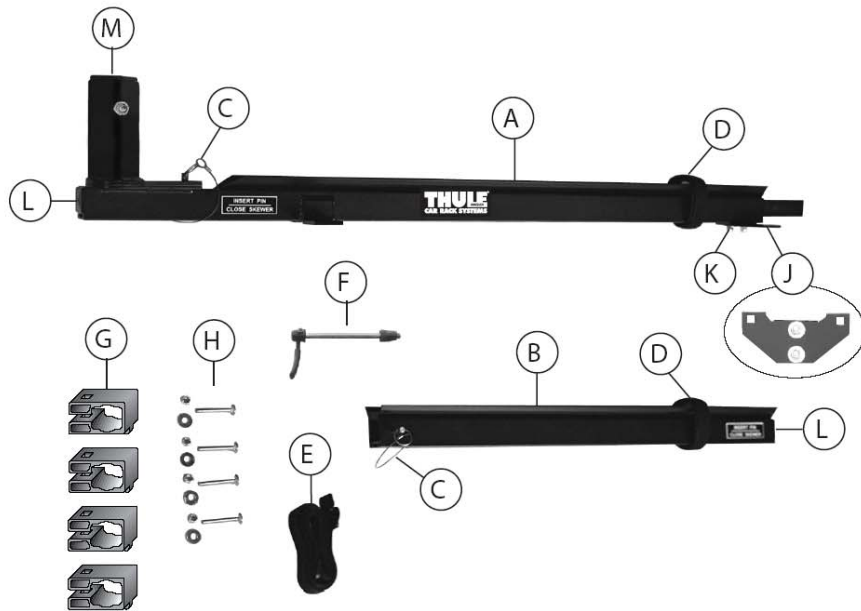

Part	Description	Qty
A	Front Beam	1
B	Tail Beam Extension	1
C	Pivot / Tail Pin Assembly	2
D	Wheel Strap Assembly	2
E	Handlebar Strap	1
F	Skewer	1
G	Mounting Clamp	4
H	Mounting Clamp Bolt Set (5/16-18 x 2 1/4 carriage bolt, nylok nut, washer)	4
J	Rear Bracket	1
K	Rear Bracket Bolt Set (5/16-18 x 3/4 carriage bolt, nylok nut, washer)	2
L	End Cap	2
M	Top Cap	1

HELPFUL HINTS

- If you are having difficulty inserting the pivot pin: A) Make sure the swivel plates are lined up by squeezing them together from the sides. B) Make sure the handlebar strap is installed symmetrically. C) Check to be sure the holes do not have any road grit in them. If necessary, clean the holes with a cotton swab. Lubricate the pivot pin by rubbing it with candle wax. Do not use oil or grease as these will attract more grit.
- If your vehicle is a minivan with a side cargo door position the carrier so that the fork mount is over the cargo door. Open the cargo door when loading your tandem. This should eliminate side clearance problems, plus you can step up on the door sill to help reach the fork mount.
- If your tandem's chain rings contact the side of your vehicle during loading/unloading: A) Experiment with the position of the carrier on your vehicle's roof. Try moving the carrier forward or back on the roof. The carrier should be as far outboard as possible (straddling the base rack towers) without being completely outboard of the towers. You can install the carrier facing either forward or backward on your vehicle. B) If the chain rings are contacting a side window, roll down the window. You can also open the door and load/unload from between the vehicle body and door.
- The pivot pin and tail pin assemblies are identical. If you permanently installed the tail beam extension by moving the rear bracket onto the tail beam, you can replace the tail pin with a 1/4-20 x 2 bolt and nylok nut. Remove the tail pin assembly and save it as a spare for the pivot pin.

COMPATIBILITIES / RESTRICTIONS

- Bike must come equipped with a quick release front skewer.
- Measure the dimensions of your bike's front fork dropouts. Not compatible with fork dropouts less than 4 mm thick. Dropouts must be 100 mm apart.
- Not all bike forks are compatible with the 558P. If your fork has a unique feature or design that prevents your using the carrier in accordance with these instructions, do not use the carrier.
- The 558P must be the outer most carrier on your roof.
- Due to their wind resistance, it is not recommended to carry disk wheels or wheels with covers on Thule bike or wheel carriers.
- Remove all bags, panniers, pumps, child seats, and other detachable accessories from bike before loading as these may be lost in transport.
- Do not stand in traffic while loading or unloading bikes from carrier. Always load/unload bikes in a safe area.
- Failure to properly install, adjust, use, and maintain the quick release mechanism on this carrier may result in damage to the vehicle and bike as well as serious personal injury.
- Any modification to bike dropouts can cause insufficient fork mount clamping pressure and may result in damage or loss of bike.

INSTALLATION REQUIREMENTS

22" (56cm) minimum

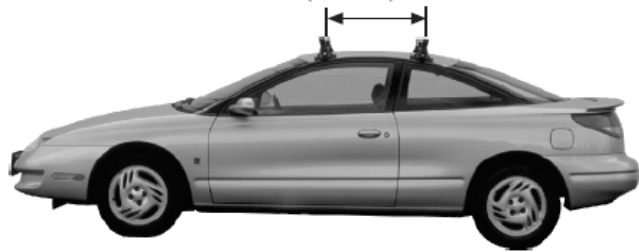

! You must have at **LEAST** a 22" (56cm) barspread

TOOLS



1/2" (13mm) wrench required for installation

1

INSTALLING TANDEM CARRIER

Carrier may be installed with or without tail beam permanently installed (see Step 1B)

Tail beam extension and strap for tandem

Front beam and strap for single bike

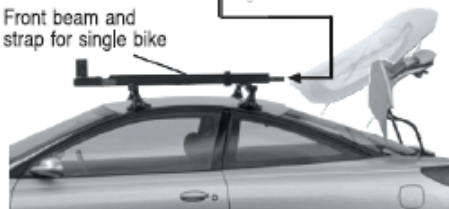

- Hatchbacks or high trunk lids may require removal of tail beam to fully open hatchback

Preferred carrier positioning

Over (straddle) rack towers



! NEVER mount completely outboard of rack towers

A Snap two mounting clamps on each load bar



B Loosen nuts to adjust rear bracket

? What if I want to position the rear bracket on the tail beam?

- Remove tail pin & disconnect tail beam from front beam
- Slide bracket off the back end of front beam
- Rearrange bracket and wheel strap on tail beam as desired
- Reconnect tail beam to front beam (see Helpful Hints section)

! Check your hatch/trunk clearance

Front beam

Tail beam

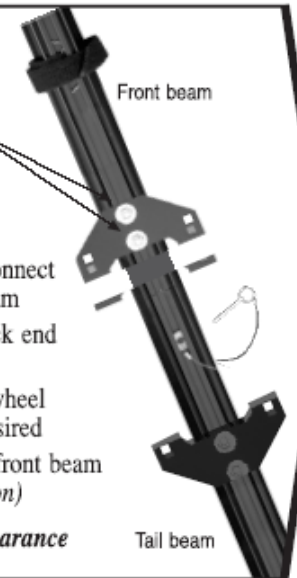

C Position carrier over mounting clamps

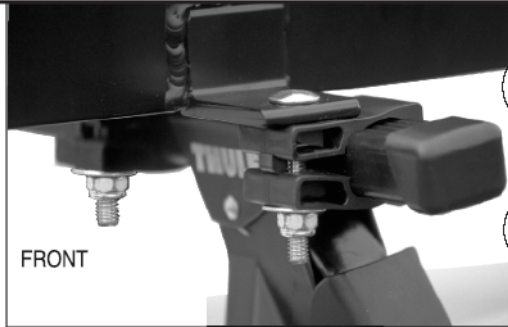
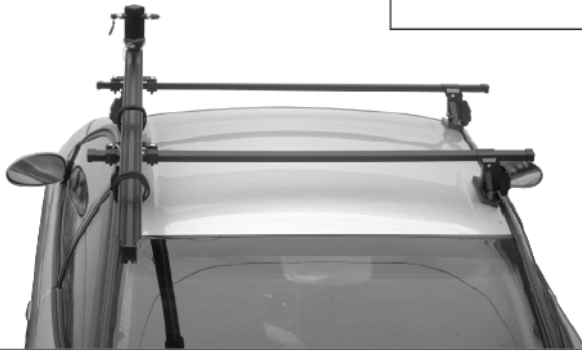

D Assemble carriage bolt, washer & nut as shown

E Tighten all six (6) nuts firmly:

- 4 mounting clamp bolts
- 2 rear bracket bolts

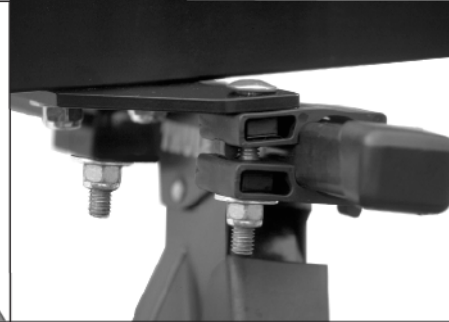

2

OPERATION

A Pull pivot pin and rotate pillar 90°

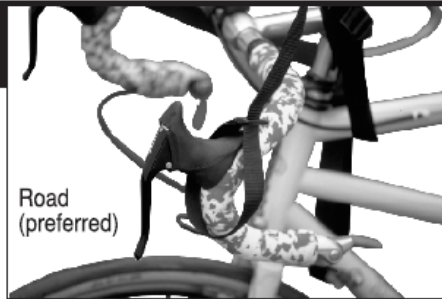

B Install handle bar strap:

- Place loops over handle bars as shown
- Thread long leg of strap through buckle and place loop over seat post as shown
- Pull strap snug and secure loose end

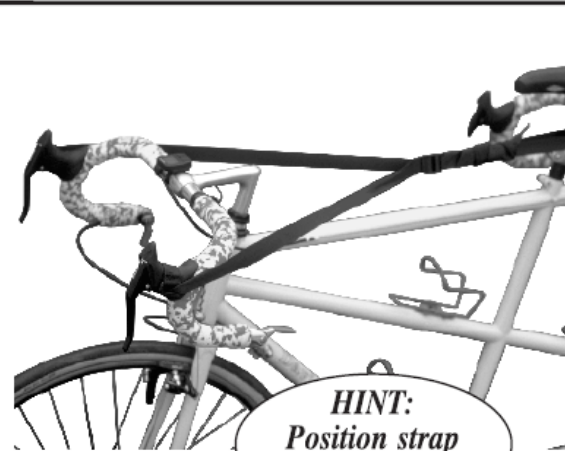

C Remove and stow front wheel
(Recumbents: also remove seats)

OTHER BAR STYLES



D

- Lift tandem into vertical position
- Roll tandem to car
- Attach fork



! Rotate cranks to avoid contact with car

Dropouts must be fully seated and straight in fork mount

!

CAUTION! Failure to use the skewer properly will result in the loss of your bicycle! A properly adjusted skewer requires firm hand pressure to close. A rule of thumb is to close the skewer with the palm or heel of your hand. The skewer should leave a distinct impression on your hand. Do not tighten the skewer by using the lever as a wing nut. If there is any question as to the proper use of the skewer, please consult your local dealer.

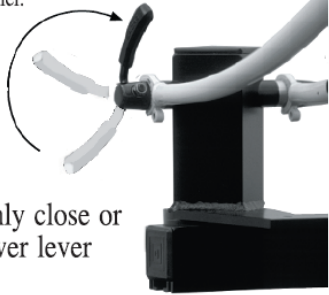

E

Firmly close or skewer lever

F

Lift and place rear wheel into tray



HINT: Grasp chainstay with both hands

!

Do not lift from wheel

G

Wrap wheel strap
NOTE: When not in use, wrap strap around beam



H

Reinsert pivot pin



!

Make sure both pivot pin & tail beam pin are inserted

3

SINGLE BIKE USE

OPTION:
Remove tail beam

A

- Remove and stow front wheel
- Load bike as with an ordinary fork mount



B

Close skewer



C

Wrap wheel strap

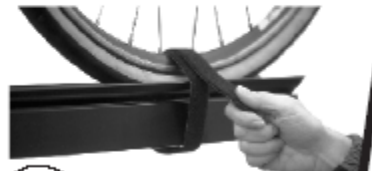

INSTALLATION TIP

To maximize the loading clearance between your tandem or recumbent and the side of your car, your Tandem Topper should be positioned so that it straddles your base rack's load bar support towers as pictured in steps 1c-1e of the Topper's directions. Your Tandem Topper's brackets will straddle the majority of support towers on the market. The exceptions are the Yakima LowRider tower, and Thule 450, 415, & 750 series towers. If your base rack uses one of these towers you may want to use Atoc's Wide Tower Adapter Bracket Kit. The WTAB Kit will improve your loading clearance by letting your Tandem Topper straddle the load bar towers. Without the WTAB Kit you will have to position your Tandem Topper completely inboard of the towers.

To purchase a WTAB Kit please see your local Atoc dealer. WTAB Kits may also be obtained from Atoc for \$13.99 (US) plus \$5.00 s/h.

Atoc Inc. • 6615 180th St SW • Lynnwood, WA 98037 • (425) 745-2131 • www.Atoc.com

MNL0015, WTAB Kit insert, Rev D.doc

© Atoc Inc. 2006