



Thule Rapid System Kit 4048

> Instructions

ISUZU MU-X, 5-dr SUV, 13-

This kit is only for vehicles with flush or integrated side railing.

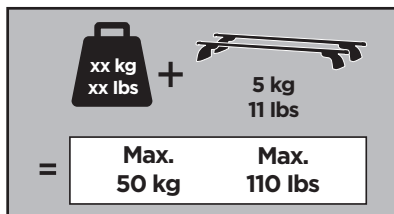
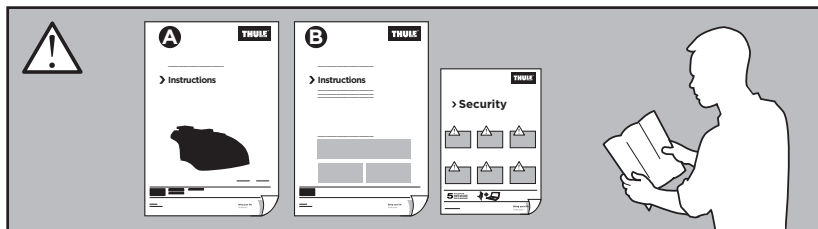

ISO 11154-E

184048

C.2014.09.21
509-4048-01

Bring your life
thule.com

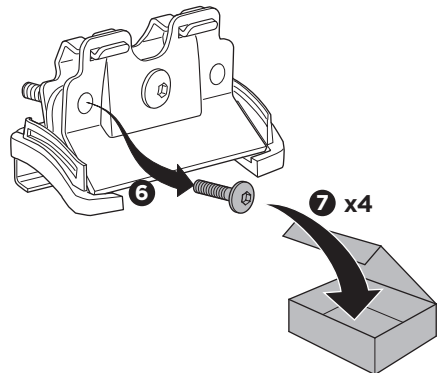
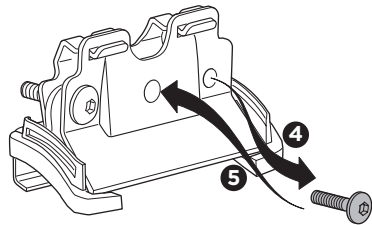
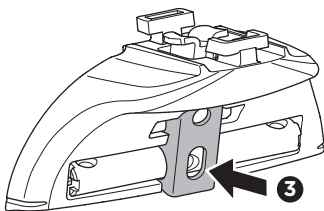
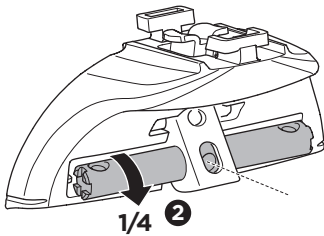
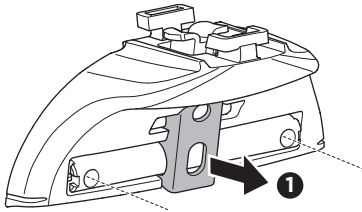
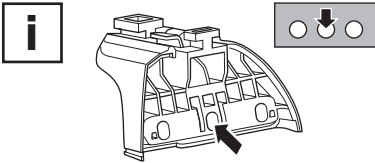
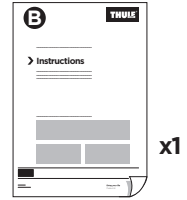
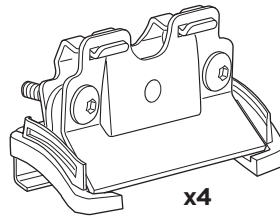
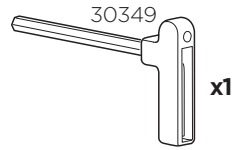
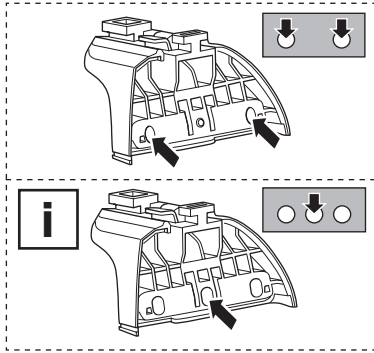

1

| | | |
|-------------------------------------|-------------------------------------|----------------------------------|
| EN Only a few turns | ET Ainult mõni pööre | RO Doar câteva rotiri |
| DE Nur wenige Umdrehungen | LV Tikai daži apgriezieni | HU Csak néhány fordítás |
| FR Quelques tours uniquement | LT Tik keli pasukimai | EL Μόνο λίγες περιστροφές |
| NL Slechts enkele slagen | PL Wystarczy kilka obrotów | TR Yalnızca birkaç tur |
| IT Solo qualche giro | RU Только несколько оборотов | بعض دورات فقط AR |
| ES Sólo algunas vueltas | UK Лише декілька обертів | רק מספר סיבובים HE |
| PT Noções básicas | BG Само няколко завъртания | ZH 仅几圈 |
| SV Endast några varv | CS Pouze několik otáček | JA 2～3回転のみ |
| DK Kun nogle få omgange | SK Len niekoľko otáčok | KO 몇 번만 돌리면 됨 |
| NE Bare noen få omdreininger | SL Le nekaj obratov | TH เพียงสองสามรอบ |
| FI Vain muutama kierros | HR/BIH Samo nekoliko okreta | |

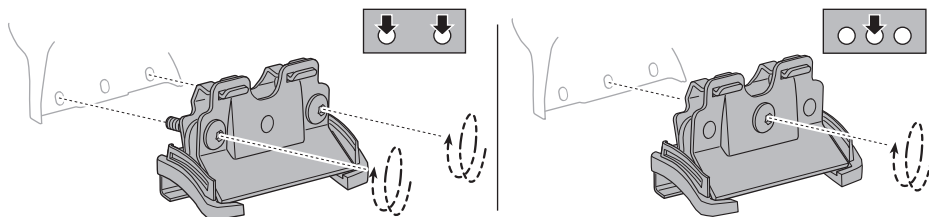
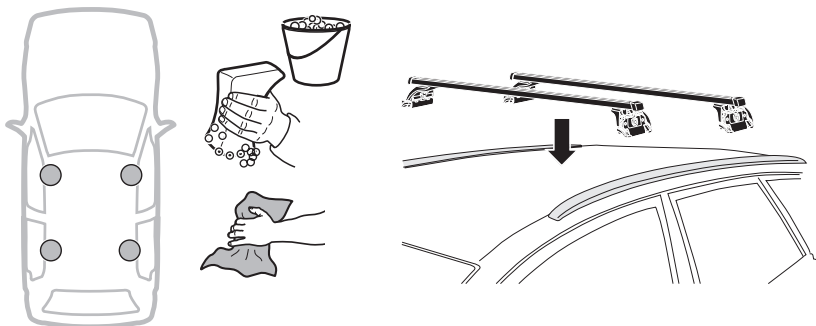
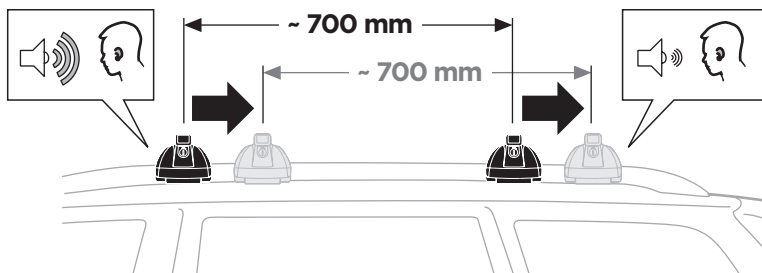
**i****2**

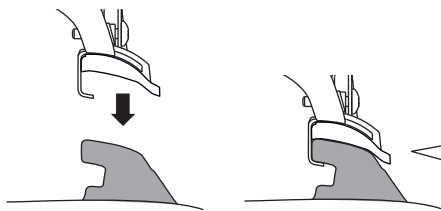

B

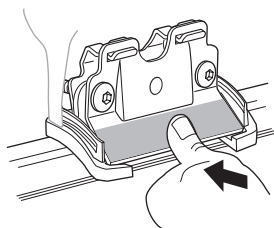

C

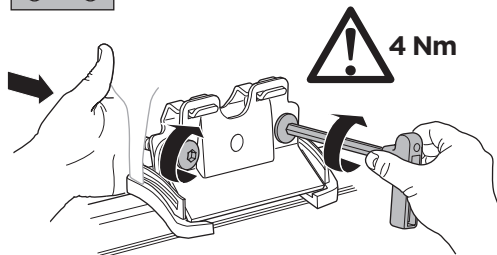

C

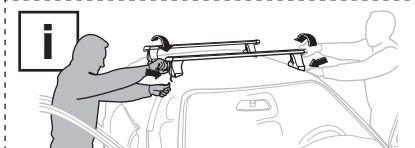
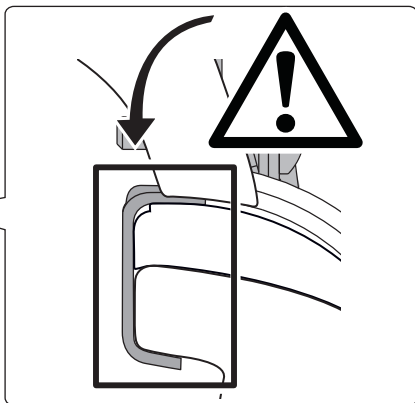
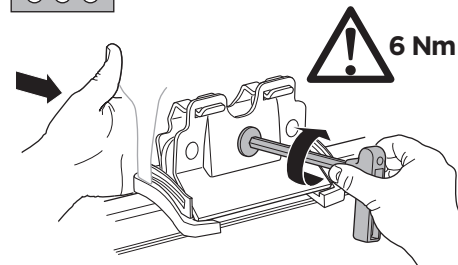

- EN** Tighten alternately
- DE** Die Schrauben abwechselnd anziehen
- FR** Serrer alternativement chaque côté
- NL** Afwisselend aan de linker- en de rechterkant aandraaien
- IT** Alternare il serraggio delle viti
- ES** Apretar alternativamente
- PT** Aperte alternadamente
- SV** Dra åt växelvis
- DK** Spænd skiftevis
- NE** Trekk til vekselvis
- FI** Kierrä vuorotellen
- ET** Pinguldage vaheldumisi
- LV** Pievelciēt pamīšus
- LT** Užsukinėkite pakaitomis
- PL** Śruby dokręcaj naprzemiennie
- RU** Затягивайте попеременно
- UK** Затягти по чергово
- BG** Затегнете последователно
- CS** Pokręťta bagazníka dokręcaj dokręcaj naprzemiennie.
- SK** Doťahujte striedavo
- SL** Privijajte izmenično
- HR/BiH** Naizmjerno zategnite
- RO** Strângeți alternativ
- HU** Egymástól függetlenül szorítandó
- EL** Ξφίγγείτε εναλλάξ
- TR** Dönüşümlü sıkın

AR إحكام الربط بالتناوب
HE חזק לסימון

- ZH** 交替拧紧
- JA** 自動固定
- KO** 번갈아 조이기
- TH** ซึ้นไปสลับกัน

