



Thule Rapid System Kit 4039

> Instructions

LAND ROVER Range Rover Sport, 5-dr SUV, 14-

This kit is only for vehicles with flush or integrated side railing.

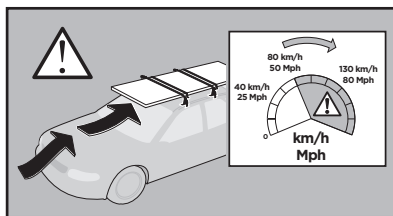
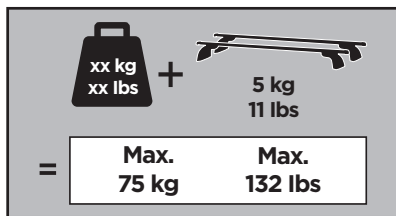
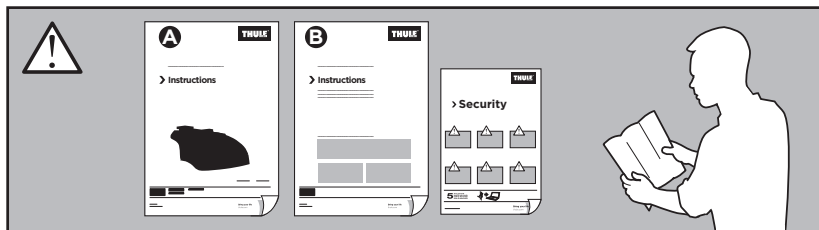

ISO 11154-E

184039

C.20141010
509-4039-01

Bring your life
thule.com



30349

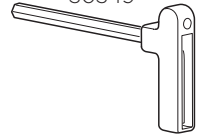

x1

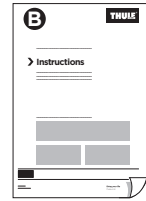

x1

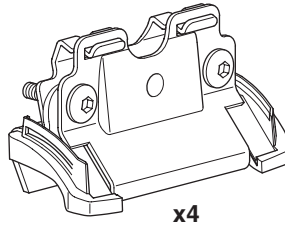

x4

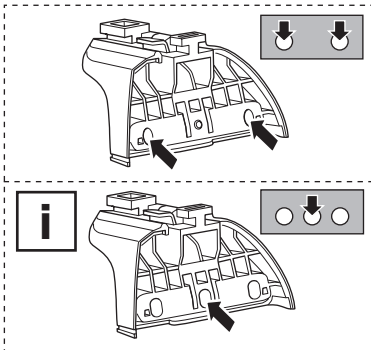

i

i

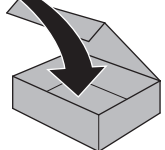
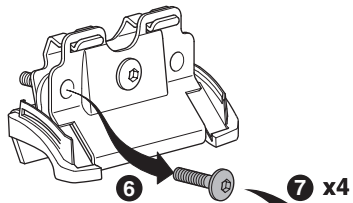
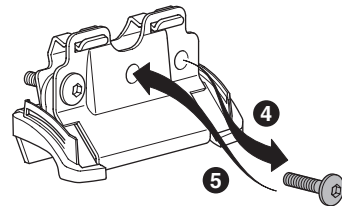
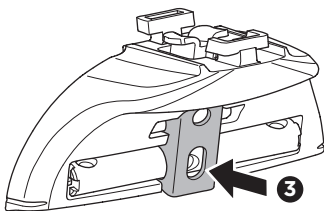
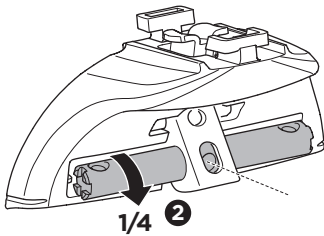
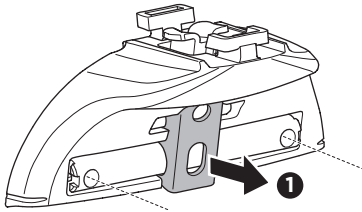
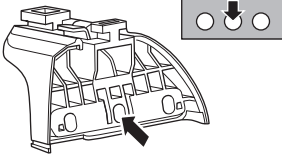

1

| | | |
|-------------------------------------|-------------------------------------|----------------------------------|
| EN Only a few turns | ET Ainult mõni pööre | RO Doar câteva rotiri |
| DE Nur wenige Umdrehungen | LV Tikai daži apgrīzieni | HU Csak néhány fordítás |
| FR Quelques tours uniquement | LT Tik keli pasukimai | EL Μόνο λίγες περιστροφές |
| NL Slechts enkele slagen | PL Wystarczy kilka obrotów | TR Yalnızca birkaç tur |
| IT Solo qualche giro | RU Только несколько оборотов | بعض دورات فقط AR |
| ES Sólo algunas vueltas | UK Лише декілька обертів | רק מספר סיבובים HE |
| PT Noções básicas | BG Само няколко завъртания | ZH 仅几圈 |
| SV Endast några varv | CS Pouze několik otáček | JA 2～3回転のみ |
| DK Kun nogle få omgange | SK Len niekoľko otáčok | KO 몇 번만 돌리면 됨 |
| NE Bare noen få omdreininger | SL Le nekaj obratov | TH เพียงสองสามรอบ |
| FI Vain muutama kierros | HR/BIH Samo nekoliko okreta | |

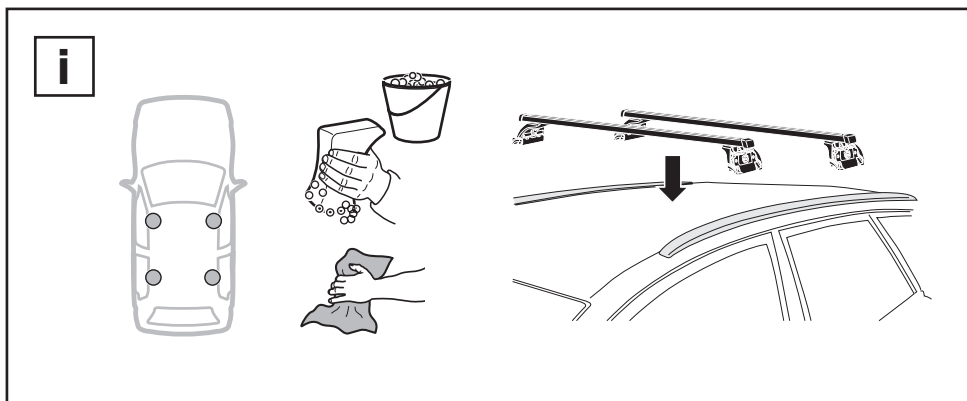
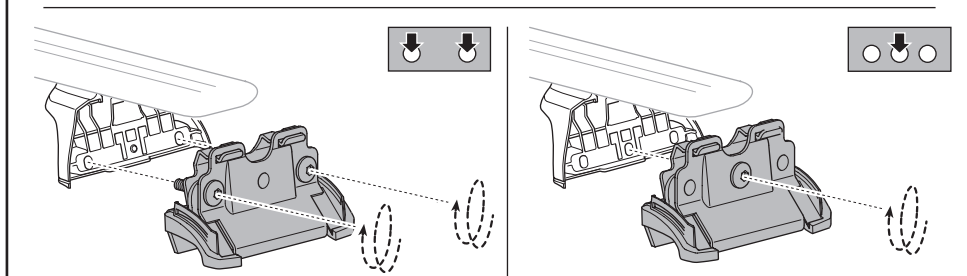
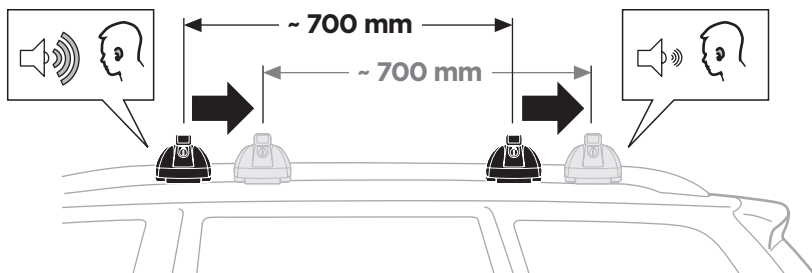
**2**

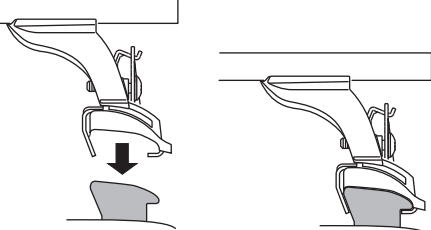
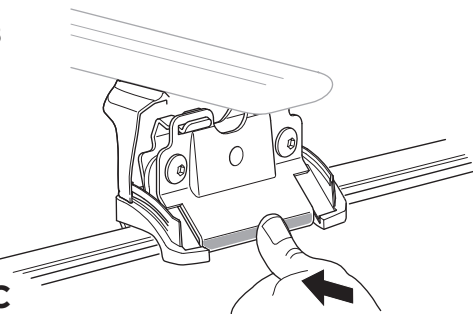
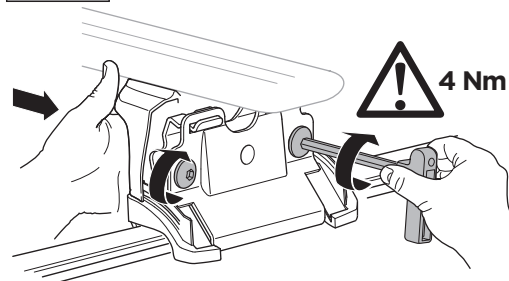
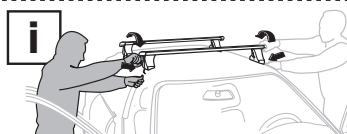
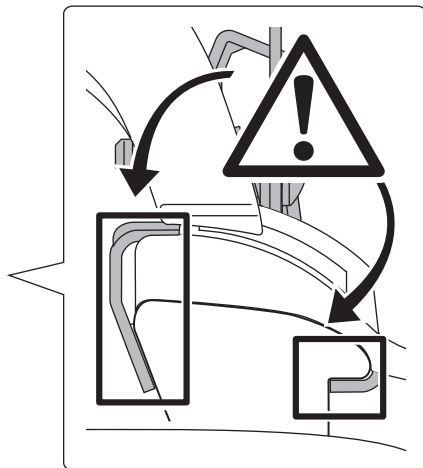
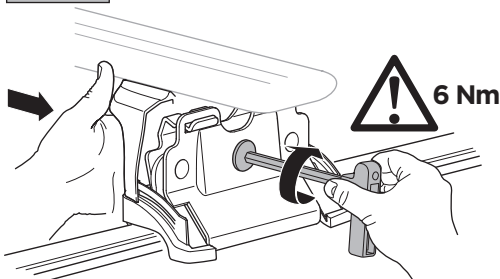
A**B****C****C**

EN Tighten alternately
 DE Die Schrauben abwechselnd anziehen
 FR Serrer alternativement chaque côté
 NL Afwisselend aan de linker- en de rechterkant aandraaien
 IT Alternare il serraggio delle viti
 ES Apretar alternativamente
 PT Aperte alternadamente
 SV Dra åt växelvis
 DK Spænd skiftevis
 NE Trekk til vekselvis
 FI Kierrä vuorotellen
 ET Pinguldage vaheldumisi
 LV Pievelciēt pamišus
 LT Užsukinėkite pakaitomis
 PL Śruby dokręcaj naprzemiennie
 RU Затягивайте попеременно
 UK Затягти по чергово
 BG Затенете последователно
 CS Pokręťta bagazníka dokręcaj naprzemiennie.
 SK Dotahujte striedavo
 SL Privijajte izmenično
 HR/BIH Naizmjenično zategnite
 RO Strângeți alternativ
 HU Egymástól függetlenül szorítandó
 EL Σφιγίετε εναλλάξ
 TR Dönüşümlü sıkın

AR إسكاف الربط بالتناوب
 HE סדק לתיקון

ZH 交替拧紧
 JA 自動固定
 KO 번갈아 조이기
 TH สลับขันสลับ

