



Rapid System Kit 4009



HYUNDAI ix35, 5-dr SUV, 10–



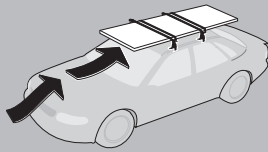

KIA Sportage, 5-dr SUV, 10– / *11–

*North America

This kit is only for vehicles with flush or integrated side railing.

 xx kg xx lbs	+	 5 kg 11 lbs	=	<table border="1"><tr><td>Max. 75 kg</td></tr><tr><td>Max. 165 lbs</td></tr></table>	Max. 75 kg	Max. 165 lbs
Max. 75 kg						
Max. 165 lbs						

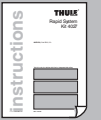
		 80 km/h 130 km/h 50 Mph 80 Mph 40 km/h 25 Mph 0 km/h Mph
---	---	---

	 security	 instructions	 instructions	
---	---	---	---	--

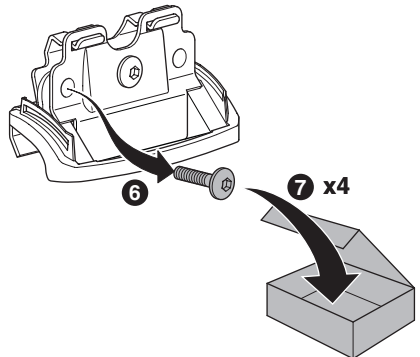
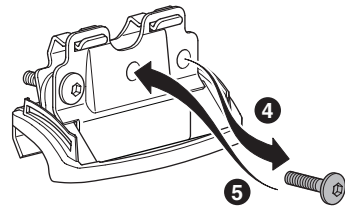
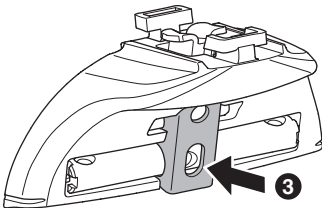
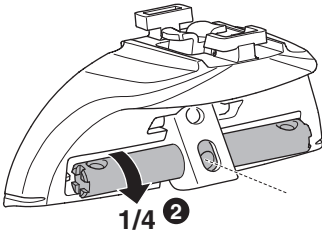
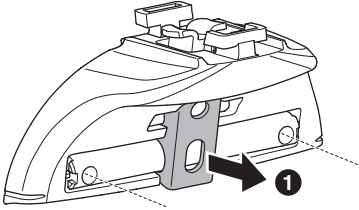
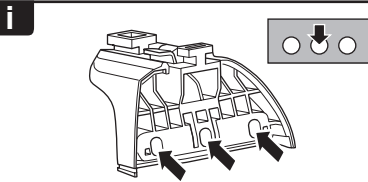
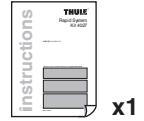
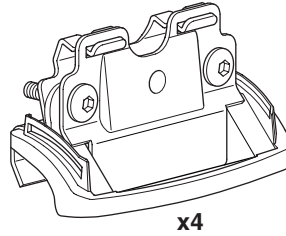
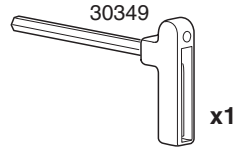
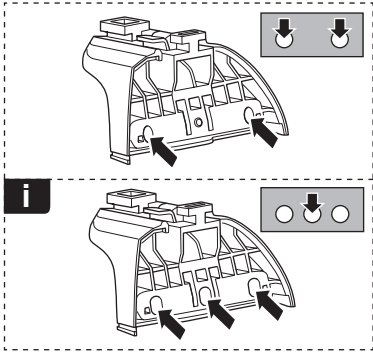

1

EN Only a few turns
 DE Nur wenige Umdrehungen
 FR Quelques tours uniquement
 NL Slechts enkele slagen
 IT Solo qualche giro
 ES Sólo algunas vueltas
 PT Noções básicas
 SV Endast några varv
 DK Kun nogle få omdrejninger
 NE Bare noen få omdreininger
 FI Vain muutama kierros

ET Ainult mõni pööre
 LV Tikai dažī apgriezieni
 LT Tik keli pasukimai
 PL Wystarczy kilka obrotów
 RU Только несколько оборотов
 UK Лише декілька обертів
 BG Само няколко завъртания
 CS Pouze několik otáček
 SK Len niekoľko otáčok
 SL Le nekaj obratov
 HR/BIH Samo nekoliko okreta

RO Doar câteva rotiri
 HU Csak néhány fordítás
 EL Μόνο λίγες περιστροφές
 TR Yalnızca birkaç tur

بعض دورات فقط
 רק מספר סיבובים

AR
 HE

ZH 仅几圈

JA 2~3回転のみ

KO 몇 번만 돌리면 됨

TH เพียงสองสามรอบ

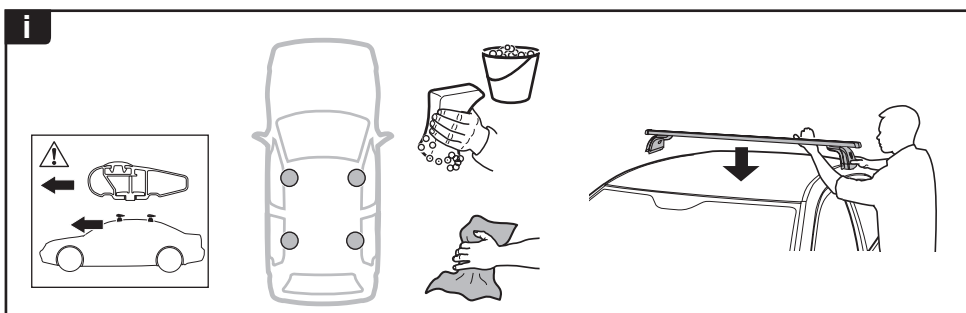
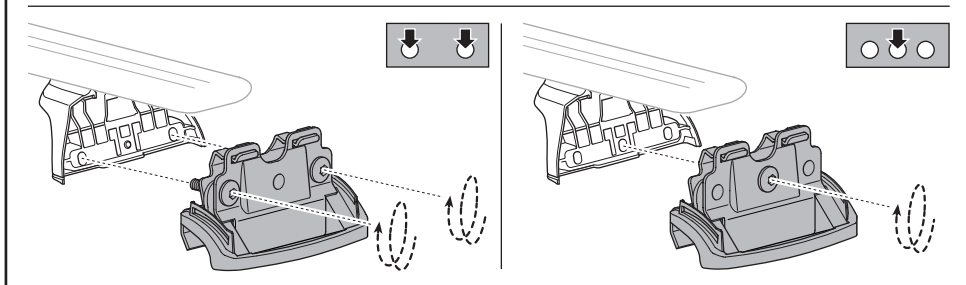
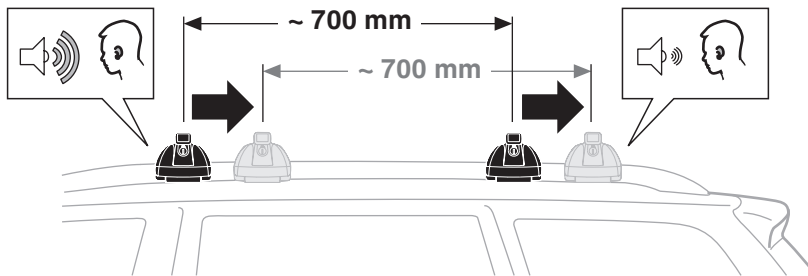
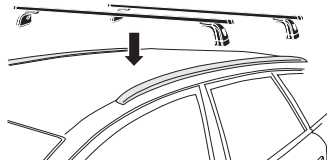
**2**

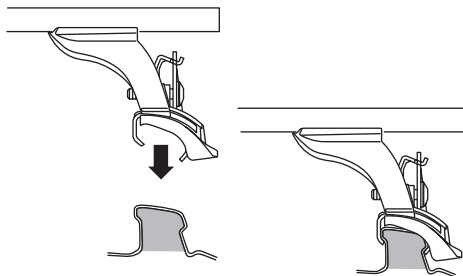
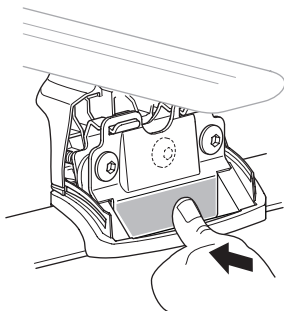
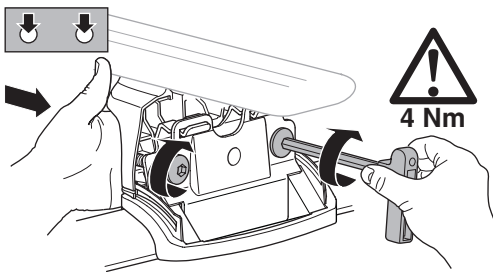
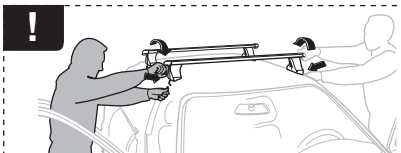
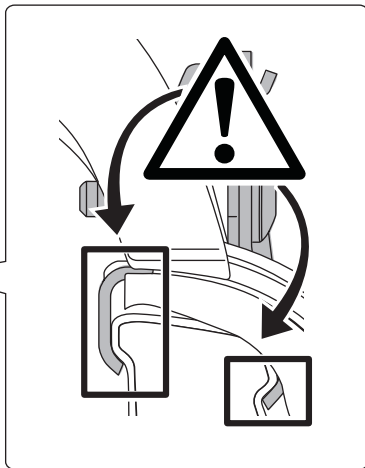
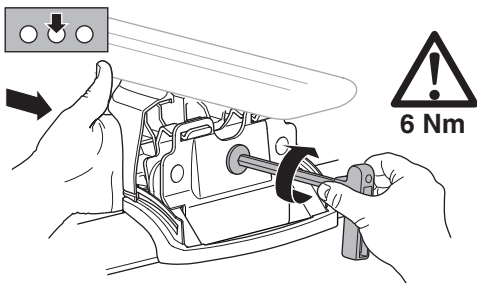
A**B****C****C**

- EN Tighten alternately
 DE Die Schrauben abwechselnd anziehen
 FR Serrer alternativement chaque côté
 NL Afwisselend aan de linker- en de rechterkant aandraaien
 IT Alternare il serraggio delle viti
 ES Apretar alternativamente
 PT Aperte alternadamente
 SV Dra åt växelvis
 DK Spænd skiftevis
 NE Trekk til vekselvis
 FI Kierrä vuorotellen
 ET Pinguldage vaheldumisi
 LV Pievelciēt pamišus
 LT Užsukinėkite pakaitomis
 PL Śruby dokręcaj naprzemiennie
 RU Затягивайте попеременно
 UK Затягти по чергово
 BG Затегнете последователно
 CS Pokrčteľta bagažníka dokrčejaj dokrčejaj naprzemiennie.
 SK Dofahujte striedavo
 SL Privijajte izmenično.
 HR/BIH Naizmjenično zategnite
 RO Strângeți alternativ
 HU Egymástól fűggetlenül szorítandó
 EL Σφιγγετε εναλλάξ
 TR Dönüşümlü sıkın

إحكام الربط بالتناوب AR
 זקוק לסירוגין HE

- ZH 交替拧紧
 JA 自動固定
 KO 번갈아 조이기
 TH สลับขันนอต

