

Thule Rapid System Kit 1682

> Instructions

CITROËN C-Zero, 5-dr Hatchback, 10-

MITSUBISHI i-MiEV, 5-dr Hatchback, 10- / *12-

*North America

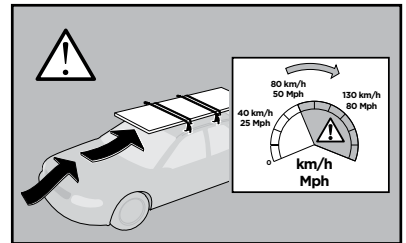
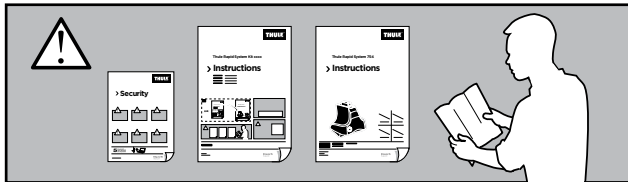
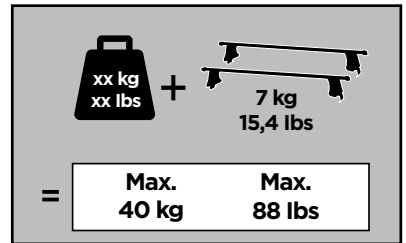
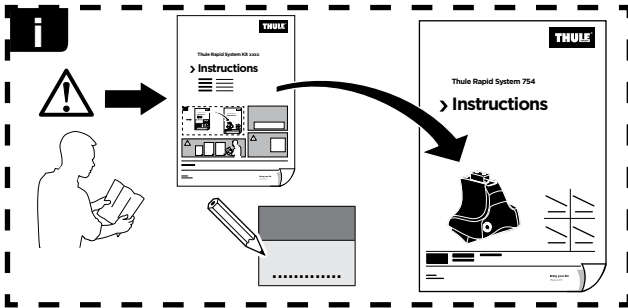

ISO 11154-E

141682

C.20120530
519-1682-01

Bring your life

thule.com



178 x2

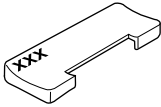

1188 x4



216 x2

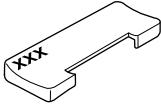

x1

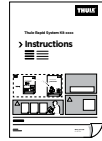

x1

1

	X (scale)	X (mm)	X (inch)
CITROËN C-Zero , 5-dr Hatchback, 10-	36,5	1016	40
MITSUBISHI i-MIEV , 5-dr Hatchback, 10- / *12-	36,5	1016	40

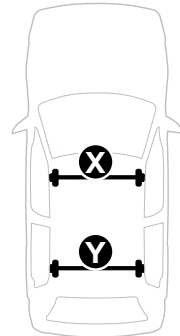
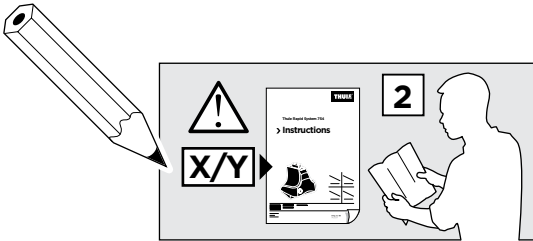

	Y (scale)	Y (mm)	Y (inch)
CITROËN C-Zero , 5-dr Hatchback, 10-	35	1001	39 ³ / ₈
MITSUBISHI i-MIEV , 5-dr Hatchback, 10- / *12-	35	1001	39 ³ / ₈

2

CITROËN C-Zero, 5-dr Hatchback, 10-
MITSUBISHI i-MiEV, 5-dr Hatchback, 10- / *12-

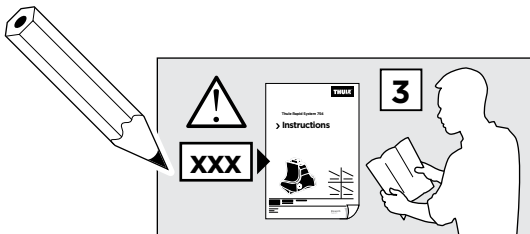
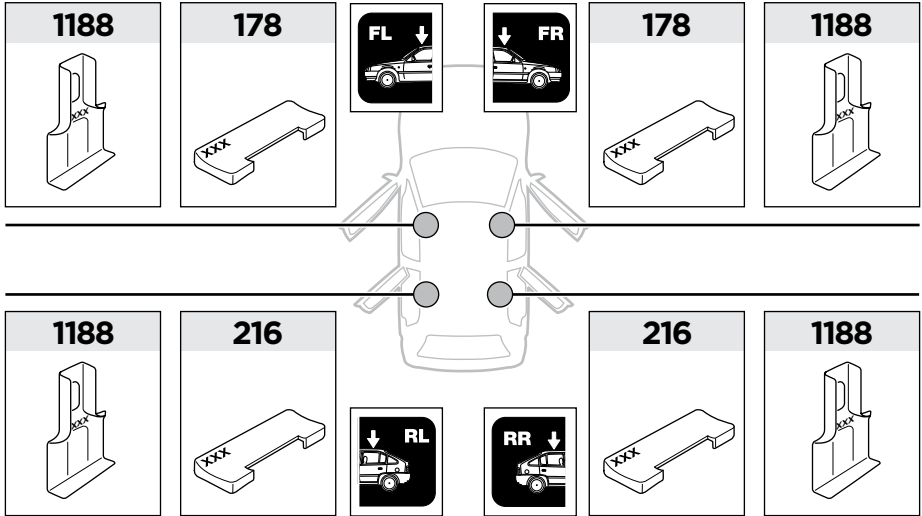

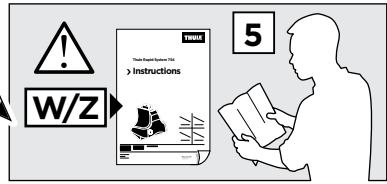
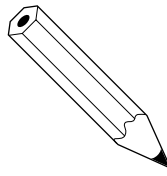
3

	W (mm)	Z (mm)	W (inch)	Z (inch)
CITROËN C-Zero , 5-dr Hatchback, 10-	410	700	16 ⁷/₈	27 ¹/₂
MITSUBISHI i-MiEV , 5-dr Hatchback, 10- / *12-	410	700	16 ⁷/₈	27 ¹/₂

