

Kit 1676

HYUNDAI Veloster, 3-dr Hatchback, 11-



754 Rapid System
480R Rapid Traverse (North America)



480 Traverse (North America)

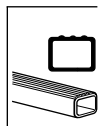

- 754 Rapid System**: x1 (box), x4 (cubes), x4 (754 Rapid System), x4 (480R Rapid Traverse (North America)), x4 (screws)
- 480R Rapid Traverse (North America)**: x1 (ruler), x4 (480R Rapid Traverse (North America)), x4 (screws)
- 480 Traverse (North America)**: x1 (ruler), x4 (480 Traverse (North America)), x4 (cubes), x4 (screws)

- Bar: x2
- Hardware: x2 (23 mm), x2 (23 mm), x4 (screws), x4 (nuts)
- Hardware: x1 (17 mm), x2 (23 mm), x2 (23 mm), x2 (nuts)
- Hardware: x2 (23 mm), x2 (nuts)
- Hardware: x2 (North America), x2 (North America)

- Bracket: x2 (679)
- Bracket: x2 (743)
- Bracket: x1 (165)
- Bracket: x1 (166)
- Bracket: x2 (239)
- Label: x1 (FR, FL, RL, RR)

1

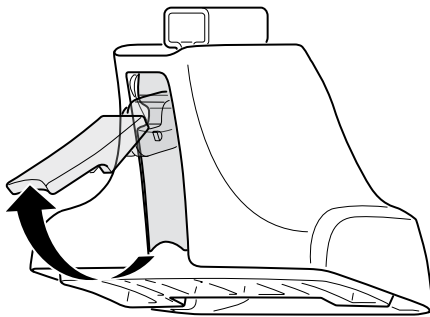

2



754 Rapid System
480R Rapid Traverse
(North America)

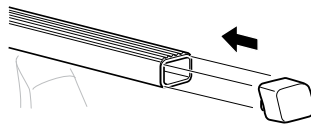
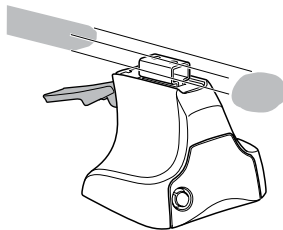

x4

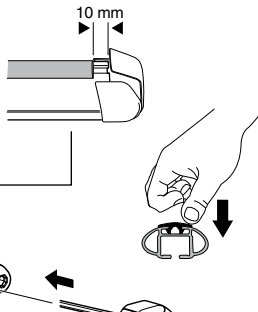
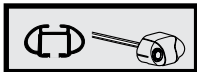

x4

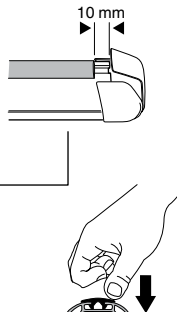
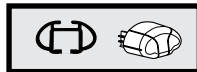

x4



480 Traverse
(North America)

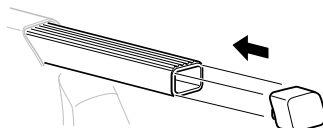
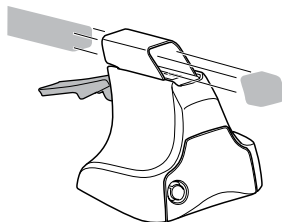

x4

3



754 Rapid System

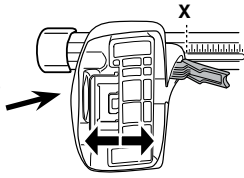

	X
HYUNDAI Veloster, 3-dr Hatchback, 11-	41

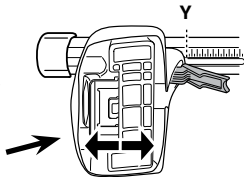

	Y
HYUNDAI Veloster, 3-dr Hatchback, 11-	43,5

3



480R Rapid Traverse



480 Traverse

(North America)

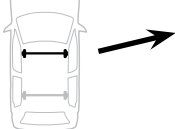

	X inch	X mm
HYUNDAI Veloster, 3-dr Hatchback, 11-	41 3/4"	1061 mm

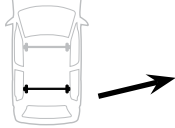

	Y inch	Y mm
HYUNDAI Veloster, 3-dr Hatchback, 11-	42 3/4"	1086 mm

4



5

HYUNDAI Veloster, 3-dr Hatchback, 11-

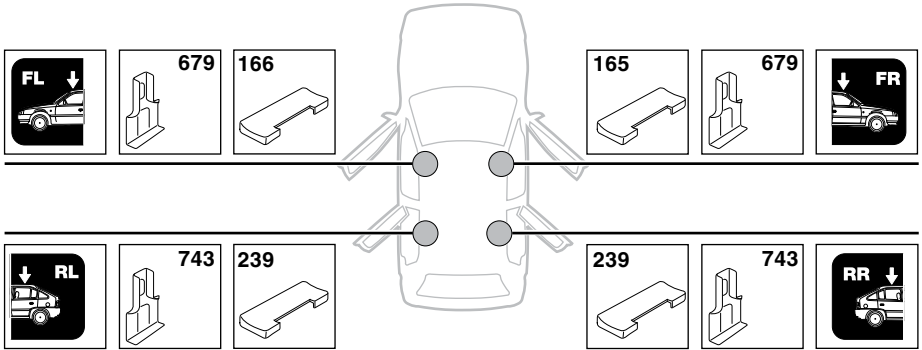

6

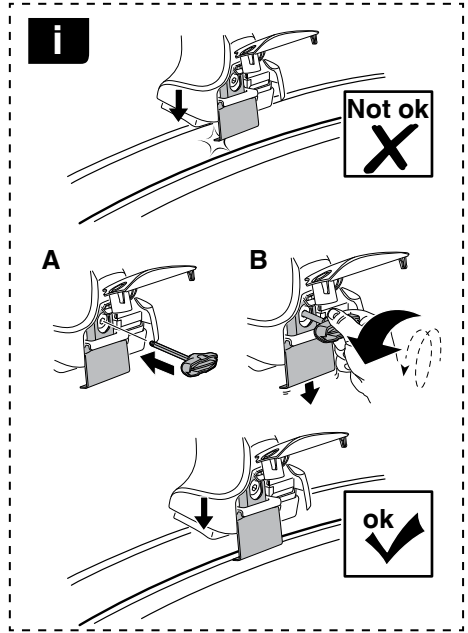

HYUNDAI Veloster, 3-dr Hatchback, 11-

X mm	Y mm	X inch	Y inch
130 mm	600 mm	5 1/8"	23 5/8"

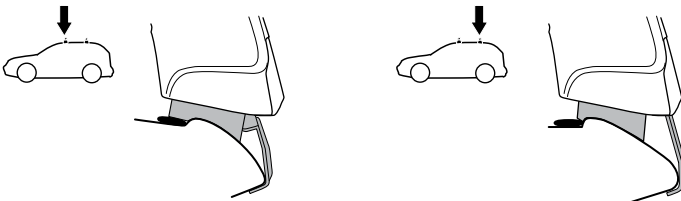
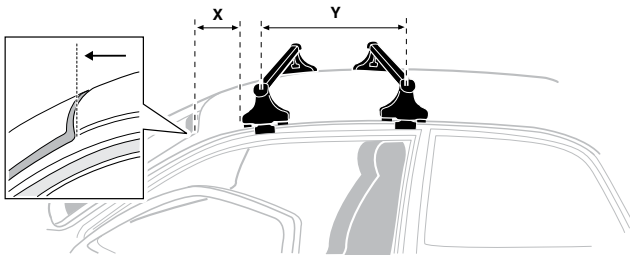

7



GB/US Tighten alternately
 D Die Schrauben abwechselnd anziehen
 F Serrer alternativement chaque côté
 NL Afwisselend aan de linker- en de rechterkant aandraaien
 I Alternare il serraggio delle viti
 E Apertar alternativamente
 PT Aperte alternadamente
 S Dra åt växelvis
 FIN Kierrä vuorotellen
 EST Pinguldage vaheldumisi
 LAT Pieļieciet pamišus
 LIT Užsukinėkite pakaitomis
 PL Śruby dokręcaj naprzemiennie
 RU Затягивайте попеременно

CZ Pokręťta bagażnika dokręcaj naprzemiennie.
 SK Dofahajte striedavo
 SLO Privijajte izmenično.
 HR Naizmjenočno zategnite
 HU Egymástól függetlenül szorítandó
 GR Σφιγίγτες εναλλάξ
 TR Dönüşümlü sıkın

中文 交替拧紧

한국어 번갈아 가며 조이십시오.

日本語 交互に締め付けてください。

ไทย ชันในแบบสลับ

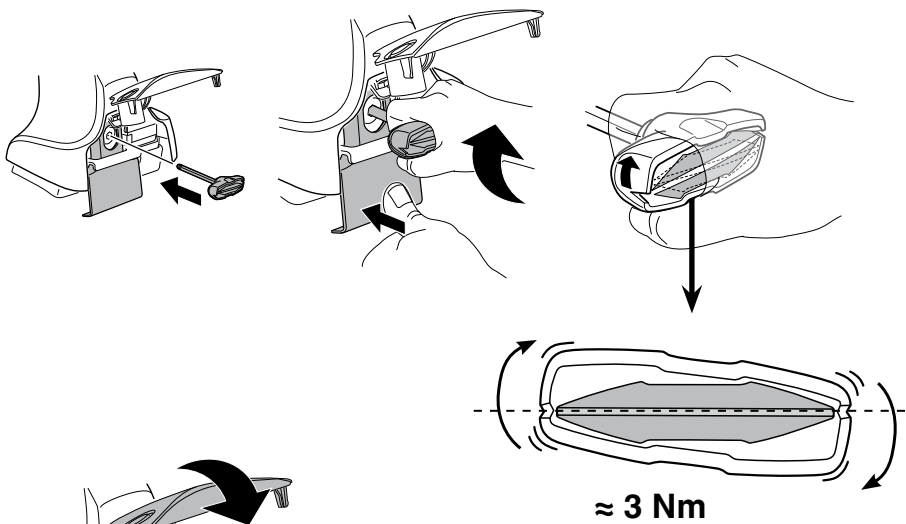

8



x1
17 mm

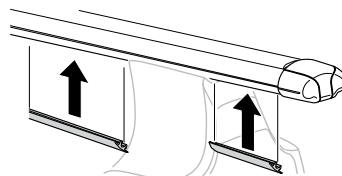
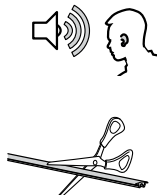

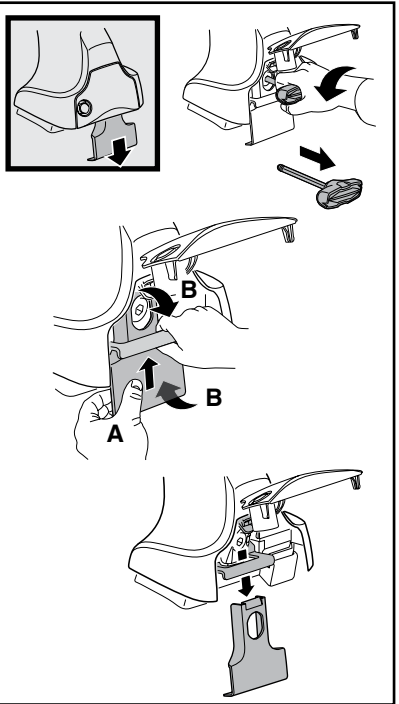
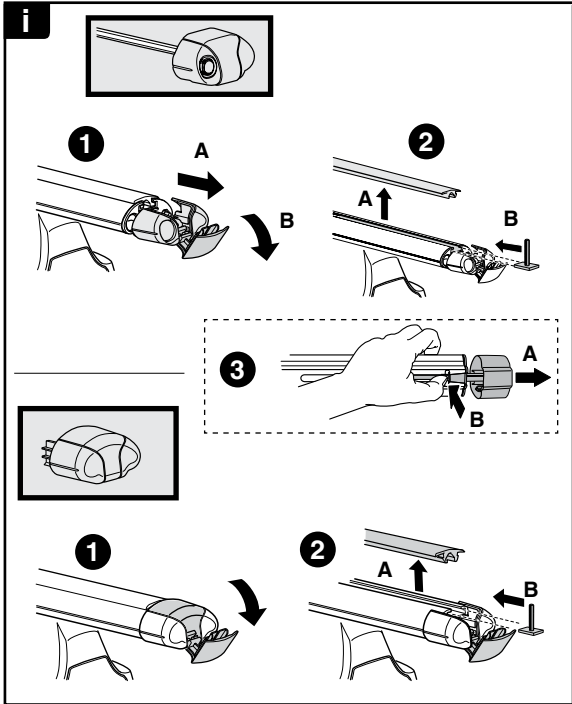

THULE
SWEDEN
**ONE
KEY
SYSTEM**

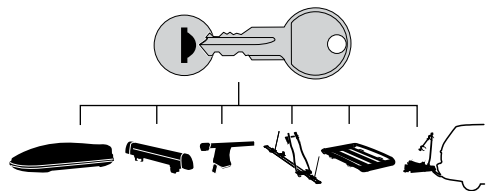

		(x4)
		(x6)
		(x8)
NA		(x10)
EUR		(x12)
ASIA		

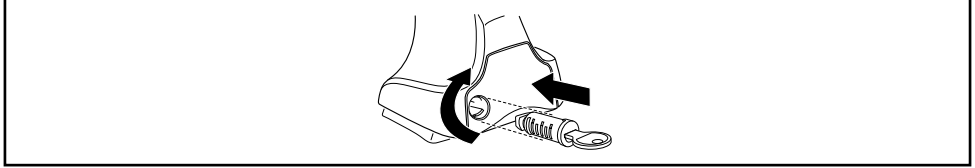

WW ▶ Thule Sweden AB, Box 69, 330 33 Hillerstorp, SWEDEN
NA ▶ Thule Inc., 42 Silvermine Road, Seymour, Connecticut 06483, USA

info@thule.com
customer.service@thule.com

www.thule.com