

Kit 1640

KIA Sportage, 5-dr SUV, 10- (Without railing)

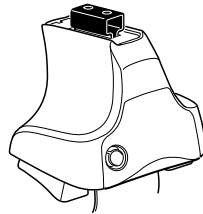

754 Rapid System
480R Rapid Traverse (North America)

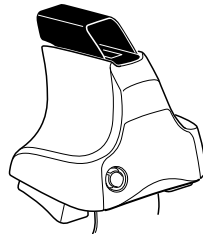
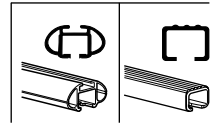

480 Traverse (North America)

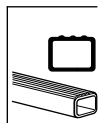

- 754 Rapid System: x1 (box), x4 (cubes), x4 (754 Rapid Traverse (North America) units), x4 (screws)
- 480R Rapid Traverse (North America): x1 (ruler), x4 (480R Rapid Traverse (North America) units), x4 (screws), x4 (cubes)
- 480 Traverse (North America): x1 (ruler), x4 (480 Traverse (North America) units), x4 (screws), x4 (cubes)

- Bar: x2
- Hardware: x2 (23 mm), x2 (23 mm), x4 (screws), x4 (nuts)
- Hardware: x1 (17 mm), x2 (23 mm), x2 (23 mm), x2 (nuts)
- Hardware: x2 (23 mm), x2 (nuts)
- (North America): x2 (hardware), x2 (bar), x2 (hardware)

- Foot: x4 (297)
- Plate: x4 (52)
- Diagram: x1 (FR, FL, RL, RR)

1



2



754 Rapid System
480R Rapid Traverse
(North America)

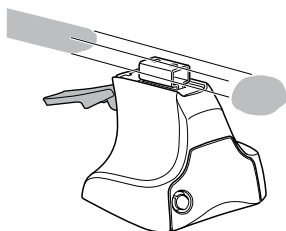

x4

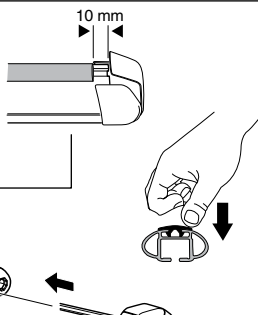
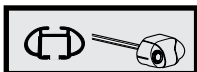

x4

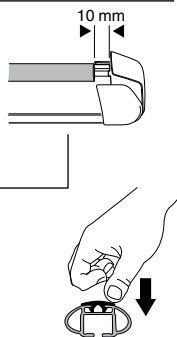
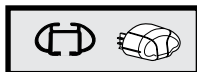

x4



480 Traverse
(North America)

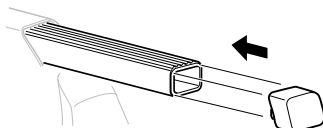

x4

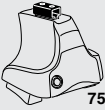
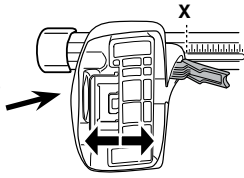
3**754** Rapid System

	X
KIA Sportage, 5-dr SUV, 10-	43,5

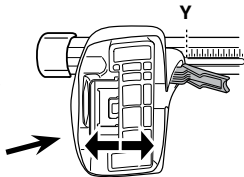

	Y
KIA Sportage, 5-dr SUV, 10-	39,5

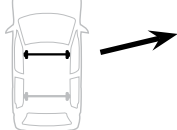
3**480R** Rapid Traverse**480** Traverse**(North America)**

	X inch	X mm
KIA Sportage, 5-dr SUV, 10-	42 3/4"	1086 mm

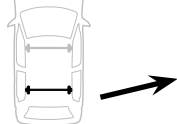

	Y inch	Y mm
KIA Sportage, 5-dr SUV, 10-	41 1/8"	1046 mm

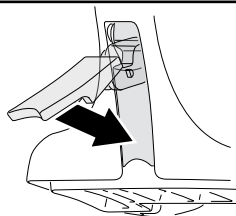
4

5

KIA Sportage, 5-dr SUV, 10-

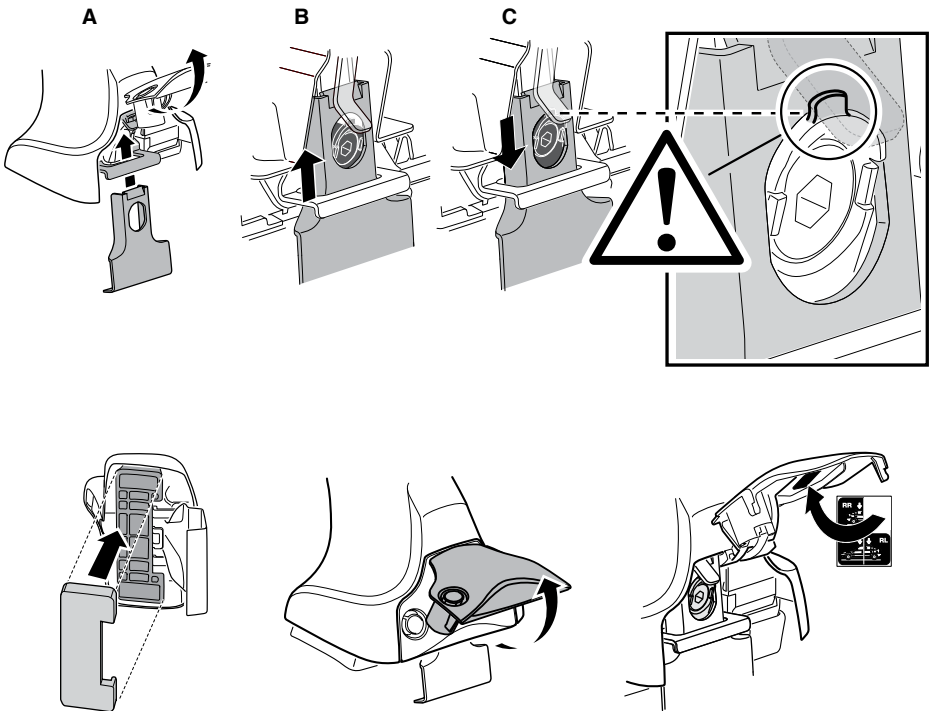
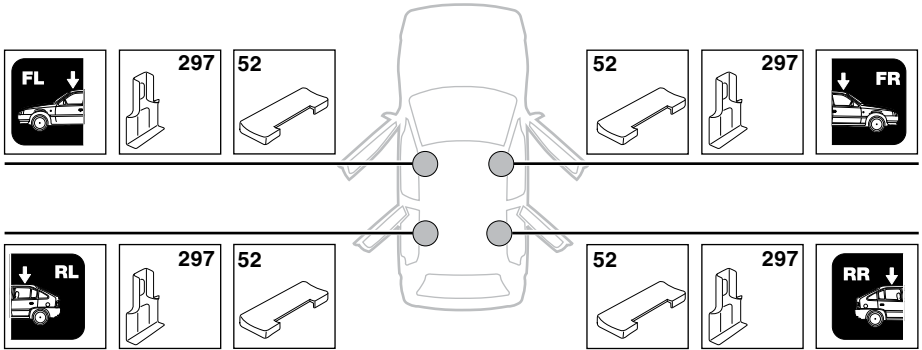

6

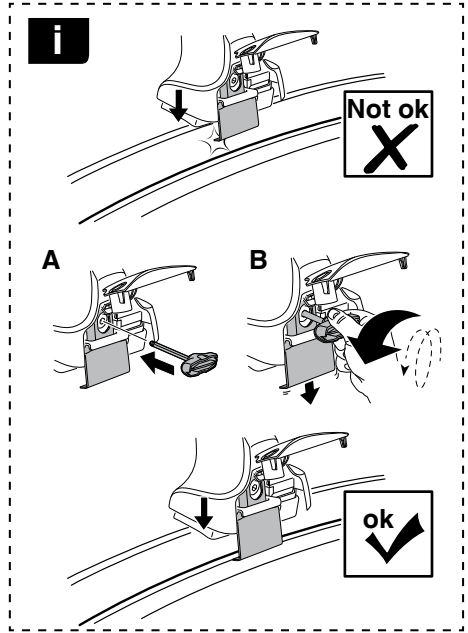

KIA Sportage, 5-dr SUV, 10-

X mm

Y mm

X inch

Y inch

360 mm

700 mm

14 1/8"

27 1/2"

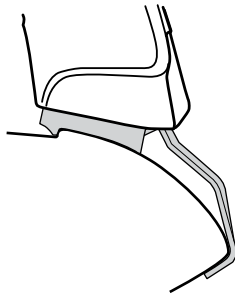
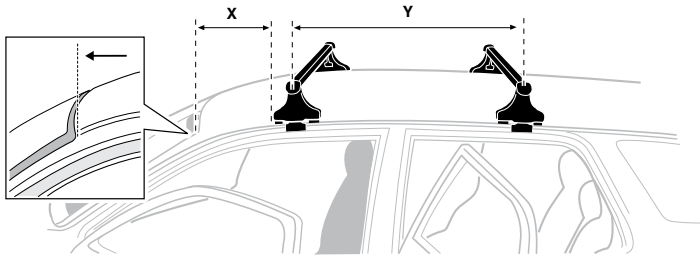

7



GB/US Tighten alternately
D Die Schrauben abwechselnd anziehen
F Serrer alternativement chaque côté
NL Afwisselend aan de linker- en de rechterkant aandraaien
I Alternare il serraggio delle viti
E Apertar alternativamente
PT Aperte alternadamente
S Dra åt växelvis
FIN Kierrä vuorotellen
EST Pinguldage vaheldumisi
LAT Pieļieciet pamišus
LIT Užsukinėkite pakaitomis
PL Śruby dokręcaj naprzemiennie
RU Затягивайте попеременно

CZ Pokręťta bagażnika dokręcaj naprzemiennie.
SK Dofahajte striedavo
SLO Privijajte izmenično.
HR Naizmjenično zategnite
HU Egymástól függetlenül szorítandó
GR Σφιγίγεται εναλλάξ
TR Dönüşümlü sıkın

中文 交替拧紧

한국어 번갈아 가며 조이십시오.

日本語 交互に締め付けてください。

ไทย ชันในแบบสลับ

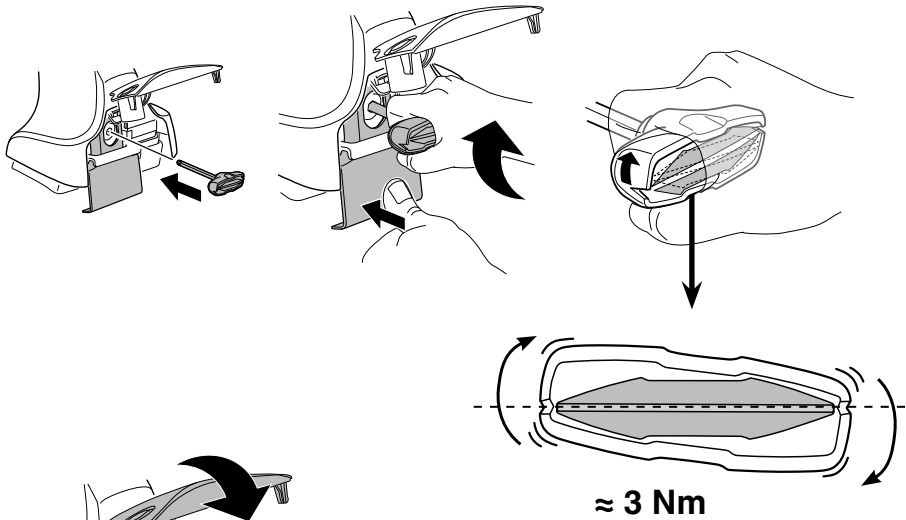

8



x1
17 mm

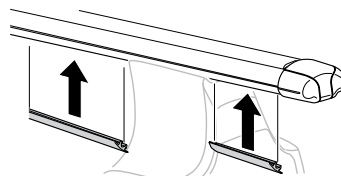
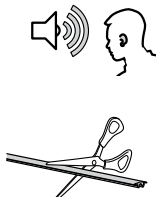

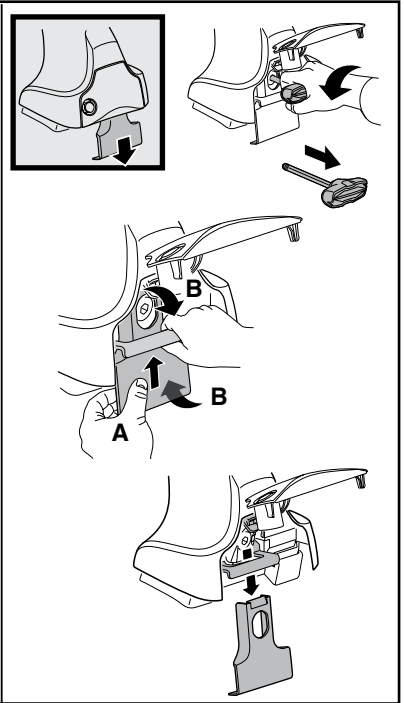
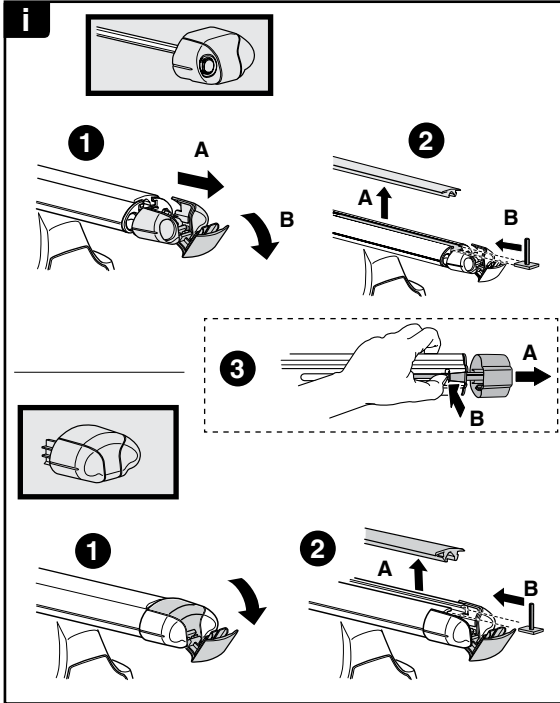

THULE
SWEDEN
**ONE
KEY
SYSTEM**



		(x4)
		(x6)
		(x8)
NA		(x10)
EUR		(x12)
ASIA		



WW ▶ Thule Sweden AB, Box 69, 330 33 Hillerstorp, SWEDEN
NA ▶ Thule Inc., 42 Silvermine Road, Seymour, Connecticut 06483, USA

info@thule.com
customer.service@thule.com

www.thule.com