

# Kit 1574

**SUBARU Legacy**, 4-dr Sedan, 09- / \*10-

**SUBARU Liberty**, 4-dr Sedan, 09-

**SUBARU Outback**, 4-dr Sedan, \*10-

\*North America

480R  
754

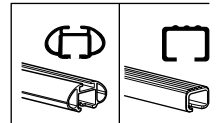
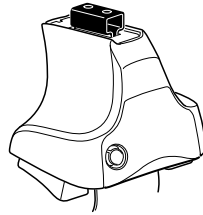

480

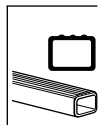
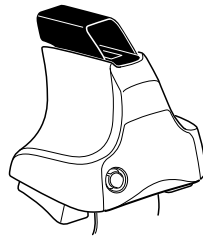

xx kg  
xx lbs + 7 kg  
15,4 lbs =

**Max.  
50 kg**  
**Max.  
110 lbs**

**THULE**  
**instructions**  
**Kit XXXX**  
**THULE**

x1

x4  
 x4

x4

480R/754

x1

x4  
 x4

x4

480

 x2	 x2 23 mm	 x2 17 mm	 x2 23 mm	 x2
	 x2	 x2 23 mm	 x2	
	 x4	 x2	 x4	

 202 x 2	 120 x 2	 x1
 368 x 2	 121 x 2	

**Kit**

1

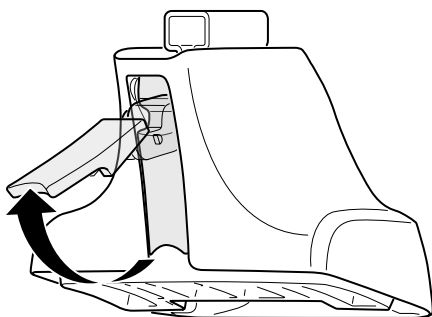
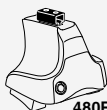

2



+

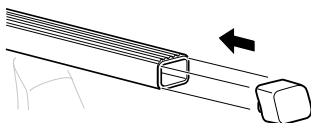
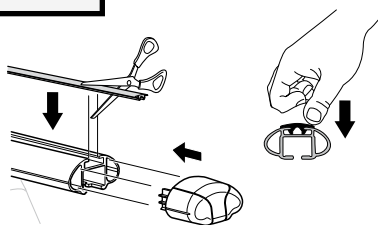
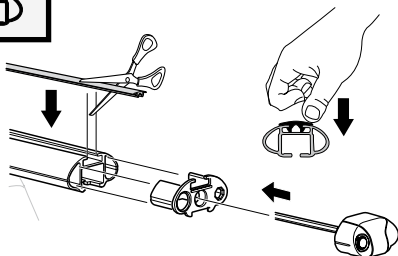
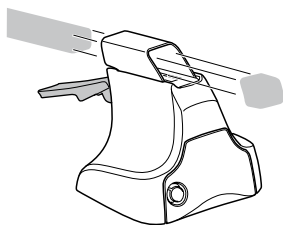
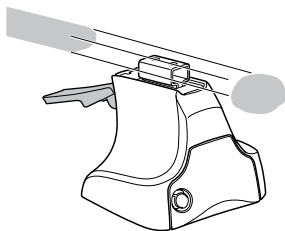

3

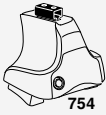

754

1

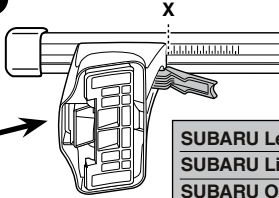
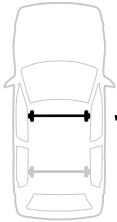

2

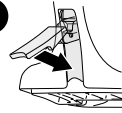

	X
SUBARU Legacy, 4-dr Sedan, 09- / *10-	44
SUBARU Liberty, 4-dr Sedan, 09-	44
SUBARU Outback, 4-dr Sedan, *10-	44

1

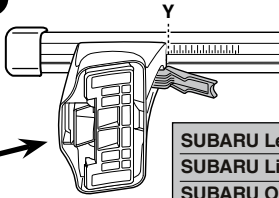

2

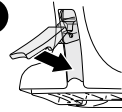

	Y
SUBARU Legacy, 4-dr Sedan, 09- / *10-	40,5
SUBARU Liberty, 4-dr Sedan, 09-	40,5
SUBARU Outback, 4-dr Sedan, *10-	40,5



480R

480

1

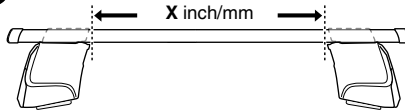
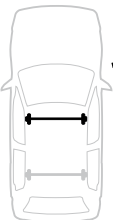

2

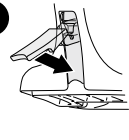

	X inch	X mm
SUBARU Legacy, 4-dr Sedan, 09- / *10-	43"	1091 mm
SUBARU Liberty, 4-dr Sedan, 09-	43"	1091 mm
SUBARU Outback, 4-dr Sedan, *10-	43"	1091 mm

1

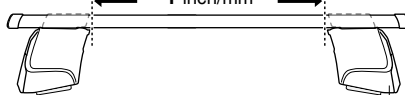

2



	Y inch	Y mm
SUBARU Legacy, 4-dr Sedan, 09- / *10-	41 <sup>5</sup> / <sub>8</sub> "	1056 mm
SUBARU Liberty, 4-dr Sedan, 09-	41 <sup>5</sup> / <sub>8</sub> "	1056 mm
SUBARU Outback, 4-dr Sedan, *10-	41 <sup>5</sup> / <sub>8</sub> "	1056 mm

4

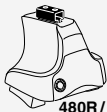

480R/754



480

SUBARU Legacy, 4-dr Sedan, 09-/\*10-  
SUBARU Liberty, 4-dr Sedan, 09-  
SUBARU Outback, 4-dr Sedan, \*10-

121



202

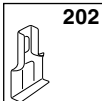

FL



120



202

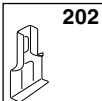

FR



120



368

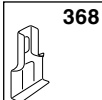

RL



121



368

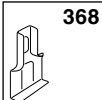

RR

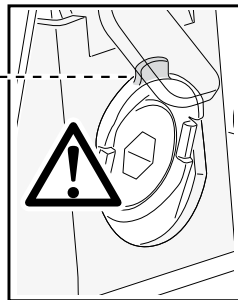
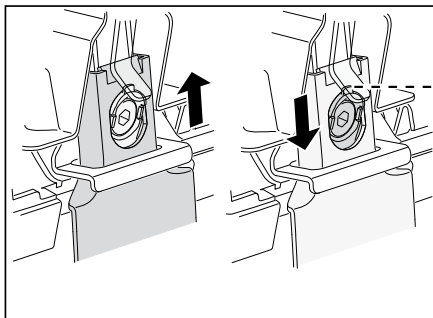
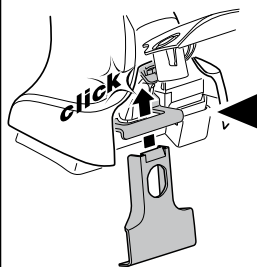
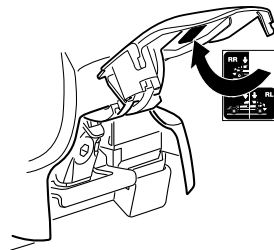
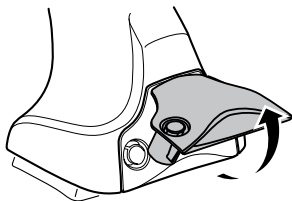
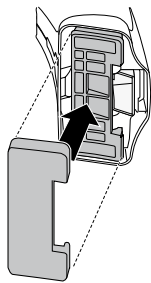

5



	X mm	Y mm	X inch	Y inch
SUBARU Legacy, 4-dr Sedan, 09- / *10-	270 mm	700 mm	10 5/8"	27 1/2"
SUBARU Liberty, 4-dr Sedan, 09-	270 mm	700 mm	10 5/8"	27 1/2"
SUBARU Outback, 4-dr Sedan, *10-	270 mm	700 mm	10 5/8"	27 1/2"

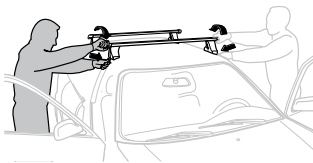
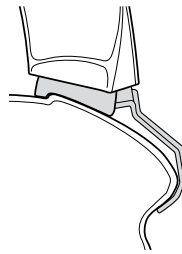
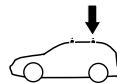
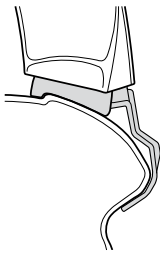
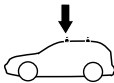
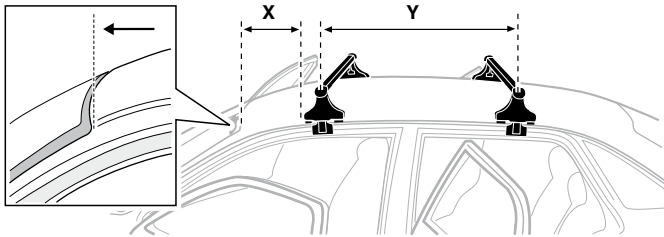

- GB/US** Tighten alternately  
**D** Die Schrauben abwechselnd anziehen  
**F** Serrer alternativement chaque côté  
**NL** Afwisselend aan de linker- en de rechterkant aandraaien  
**I** Alternare il serraggio delle viti  
**E** Apretar alternativamente  
**PT** Aperte alternadamente  
**S** Dra åt växelvis  
**FIN** Kierrä vuorotellen  
**EST** Pinguldage vaheldumisi  
**LAT** Pievelciēt pamišus  
**LIT** Užsukinėkite pakaitomis  
**PL** Śruby dokręcaj naprzemiennie  
**RU** Затягивайте попеременно

- CZ** Pokrétla bagážnika dokręcaj dokręcaj naprzemiennie.  
**SK** Dofahujte striedavo  
**SLO** Privijajte izmenično.  
**HR** Naizmjenično zategnite  
**HU** Egymástól függetlenül szorítandó  
**GR** Σφιγγείτε εναλλάξ  
**TR** Dönüşümlü sıkın

**中文** 交替拧紧

**한국어** 번갈아 가며 조이십시오.

**日本語** 交互に締め付けてください。

**ไทย** สลับขันในแบบสลับ

6

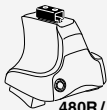

480R/754



480

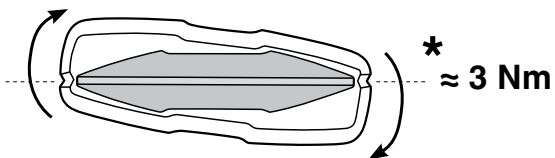
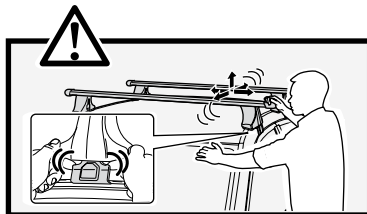
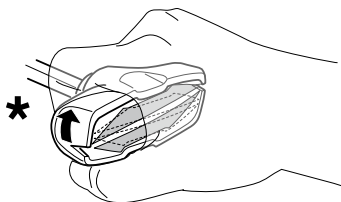
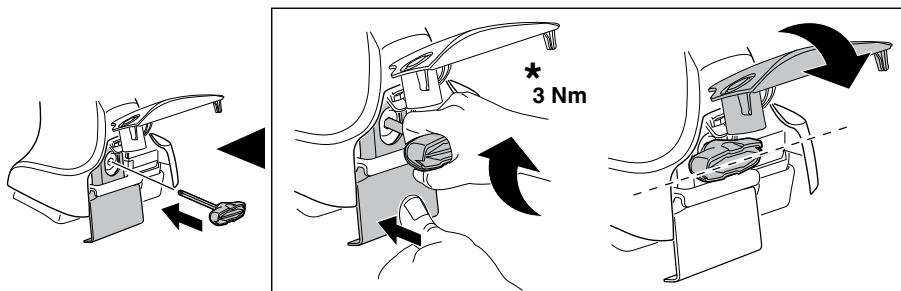

7

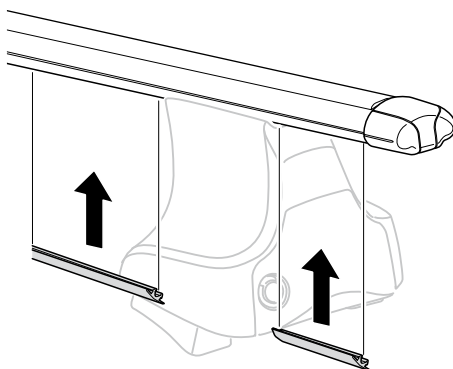
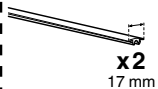

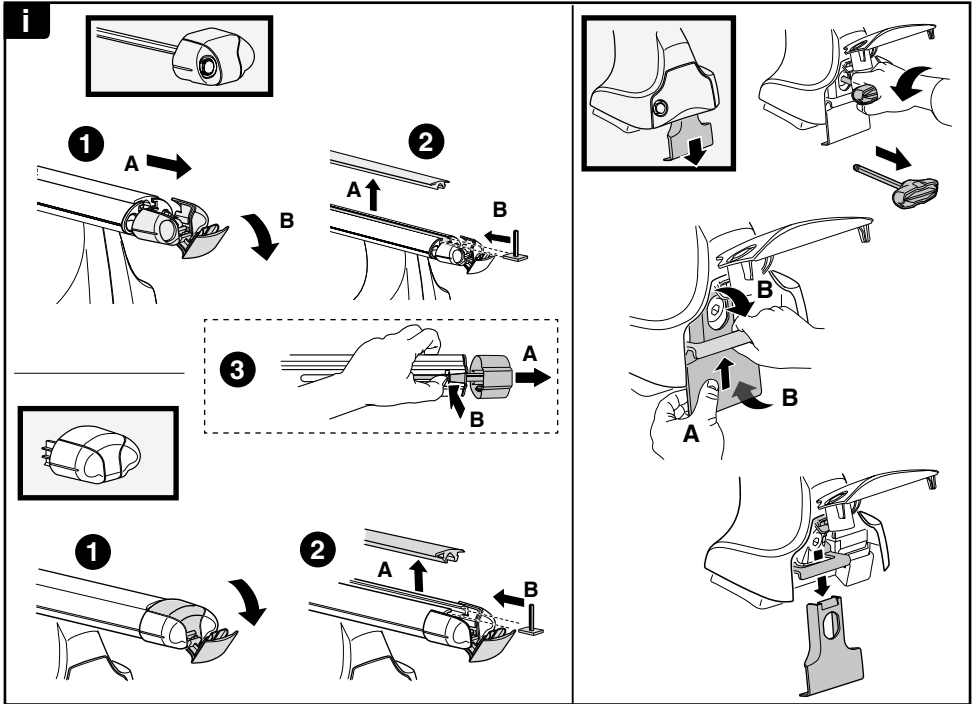
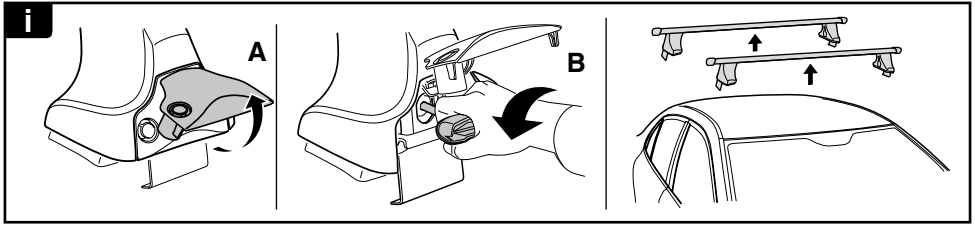

**THULE**  
SWEDEN

**ONE  
KEY  
SYSTEM**

544 (x4)

596 (x6)

588 (x8)

NA 510 (x10)

EUR 452 (x12)

ASIA

WW ▶ Thule Sweden AB, Box 69, 330 33 Hillerstorp, SWEDEN  
 NA ▶ Thule Inc., 42 Silvermine Road, Seymour, Connecticut 06483, USA

info@thule.com  
 customer.service@thule.com

www.thule.com