

# Kit 1569

**CHEVROLET Cruze**, 4-dr Sedan, 09–  
**CHEVROLET Cruze**, 4-dr Sedan, \*11–  
**CHEVROLET Cruze**, 5-dr Hatchback, 11–  
**DAEWOO Lacetti Premiere**, 4-dr Sedan, 09–  
**HOLDEN Cruze**, 4-dr Sedan, 09–

\*North America

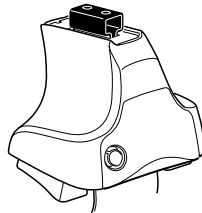

**754** Rapid System  
**480R** Rapid Traverse (North America)

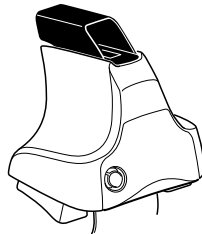
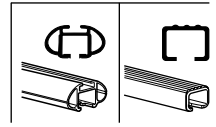

**480** Traverse (North America)

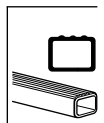



1



2



754 Rapid System  
480R Rapid Traverse  
(North America)

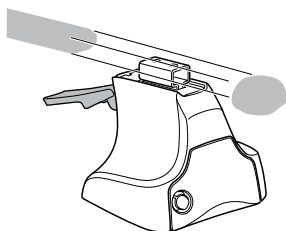

x4

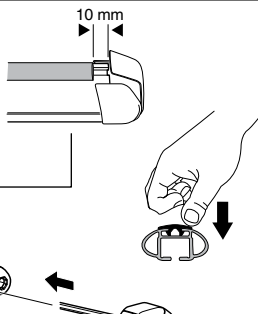
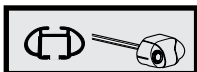

x4

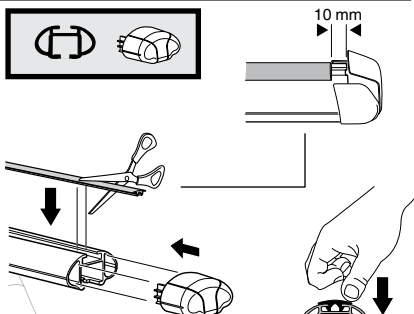
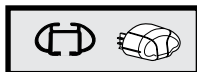

x4



480 Traverse  
(North America)

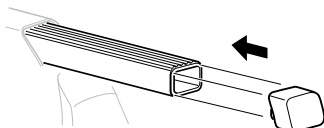

x4

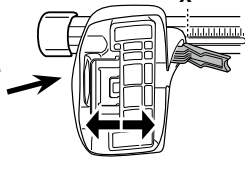
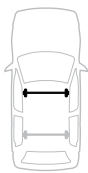
**3****754** Rapid System

	<b>X</b>
<b>CHEVROLET Cruze</b> , 4-dr Sedan, 09–	<b>35,5</b>
<b>CHEVROLET Cruze</b> , 4-dr Sedan, *11–	<b>35,5</b>
<b>CHEVROLET Cruze</b> , 5-dr Hatchback, 11–	<b>35,5</b>
<b>DAEWOO Lacetti Premiere</b> , 4-dr Sedan, 09–	<b>35,5</b>
<b>HOLDEN Cruze</b> , 4-dr Sedan, 09–	<b>35,5</b>

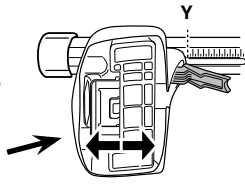

	<b>Y</b>
<b>CHEVROLET Cruze</b> , 4-dr Sedan, 09–	<b>32</b>
<b>CHEVROLET Cruze</b> , 4-dr Sedan, *11–	<b>29,5</b>
<b>CHEVROLET Cruze</b> , 5-dr Hatchback, 11–	<b>30</b>
<b>DAEWOO Lacetti Premiere</b> , 4-dr Sedan, 09–	<b>32</b>
<b>HOLDEN Cruze</b> , 4-dr Sedan, 09–	<b>32</b>

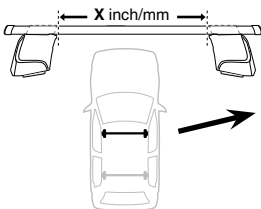
**3****480R** Rapid Traverse**480** Traverse**(North America)**

	<b>X inch</b>	<b>X mm</b>
<b>CHEVROLET Cruze</b> , 4-dr Sedan, 09–	<b>39 5/8"</b>	<b>1006 mm</b>
<b>CHEVROLET Cruze</b> , 4-dr Sedan, *11–	<b>39 5/8"</b>	<b>1006 mm</b>
<b>CHEVROLET Cruze</b> , 5-dr Hatchback, 11–	<b>39 5/8"</b>	<b>1006 mm</b>
<b>DAEWOO Lacetti Premiere</b> , 4-dr Sedan, 09–	<b>39 5/8"</b>	<b>1006 mm</b>
<b>HOLDEN Cruze</b> , 4-dr Sedan, 09–	<b>39 5/8"</b>	<b>1006 mm</b>

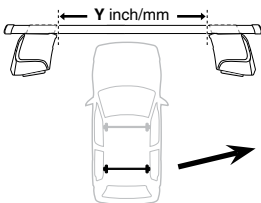

	<b>Y inch</b>	<b>Y mm</b>
<b>CHEVROLET Cruze</b> , 4-dr Sedan, 09–	<b>38 1/4"</b>	<b>971 mm</b>
<b>CHEVROLET Cruze</b> , 4-dr Sedan, *11–	<b>37 1/4"</b>	<b>946 mm</b>
<b>CHEVROLET Cruze</b> , 5-dr Hatchback, 11–	<b>37 1/2"</b>	<b>951 mm</b>
<b>DAEWOO Lacetti Premiere</b> , 4-dr Sedan, 09–	<b>38 1/4"</b>	<b>971 mm</b>
<b>HOLDEN Cruze</b> , 4-dr Sedan, 09–	<b>38 1/4"</b>	<b>971 mm</b>

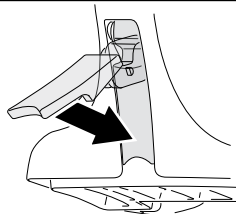
**4**

**5**

CHEVROLET Cruze, 4-dr Sedan, 09–  
 CHEVROLET Cruze, 4-dr Sedan, \*11–  
 CHEVROLET Cruze, 5-dr Hatchback, 11–  
 DAEWOO Lacetti Premiere, 4-dr Sedan, 09–  
 HOLDEN Cruze, 4-dr Sedan, 09–

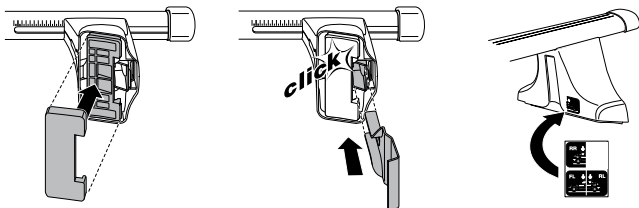
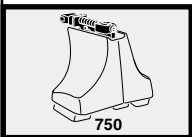
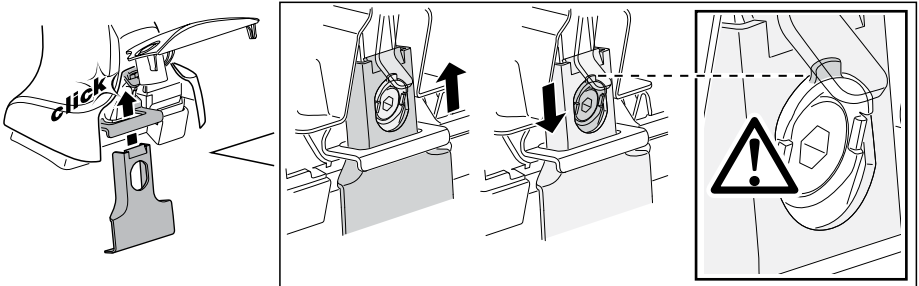
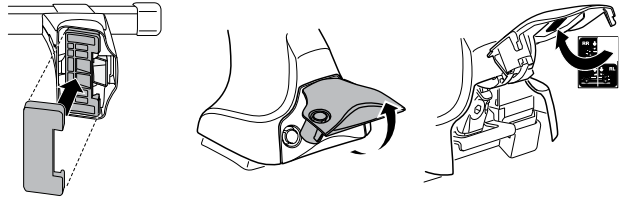
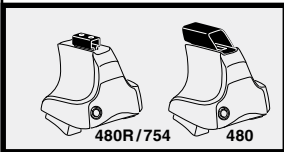
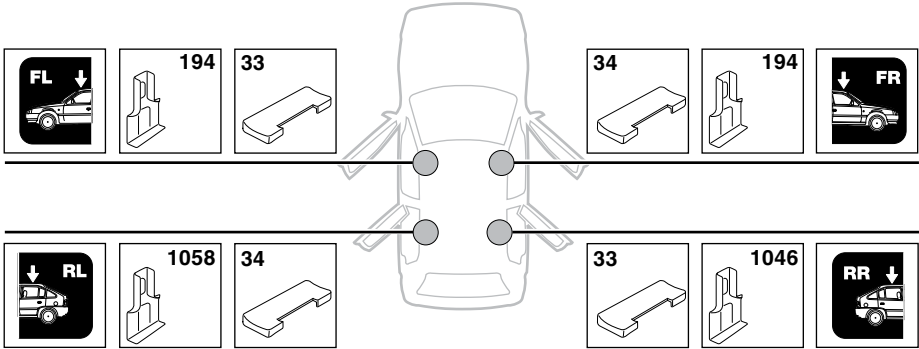

6

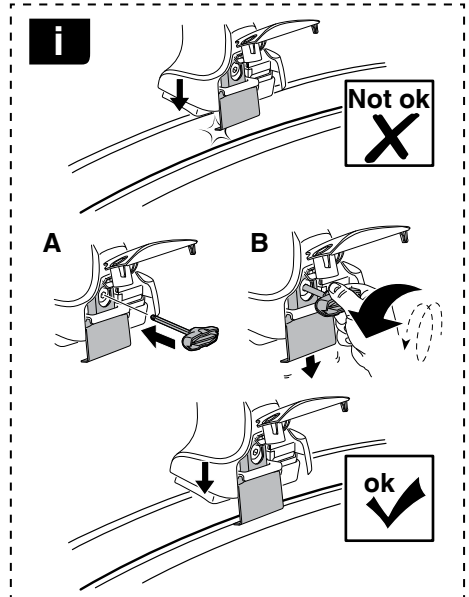
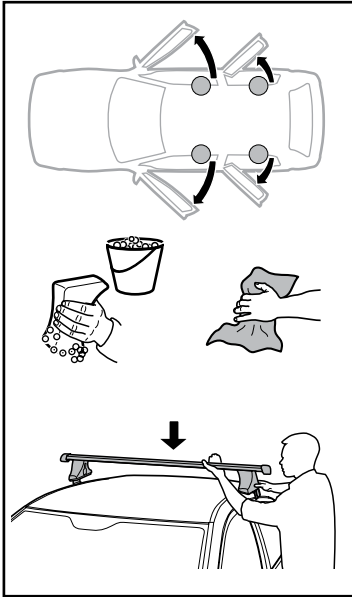

	X mm	Y mm	X inch	Y inch
CHEVROLET Cruze, 4-dr Sedan, 09-	250 mm	630 mm	9 <sup>7</sup> / <sub>8</sub> "	24 <sup>3</sup> / <sub>4</sub> "
CHEVROLET Cruze, 4-dr Sedan, *11-	250 mm	630 mm	9 <sup>7</sup> / <sub>8</sub> "	24 <sup>3</sup> / <sub>4</sub> "
CHEVROLET Cruze, 5-dr Hatchback, 11-	250 mm	630 mm	9 <sup>7</sup> / <sub>8</sub> "	24 <sup>3</sup> / <sub>4</sub> "
DAEWOO Lacetti Premiere, 4-dr Sedan, 09-	250 mm	630 mm	9 <sup>7</sup> / <sub>8</sub> "	24 <sup>3</sup> / <sub>4</sub> "
HOLDEN Cruze, 4-dr Sedan, 09-	250 mm	630 mm	9 <sup>7</sup> / <sub>8</sub> "	24 <sup>3</sup> / <sub>4</sub> "

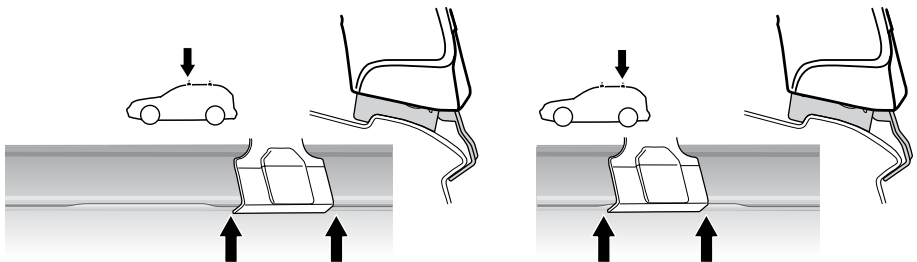
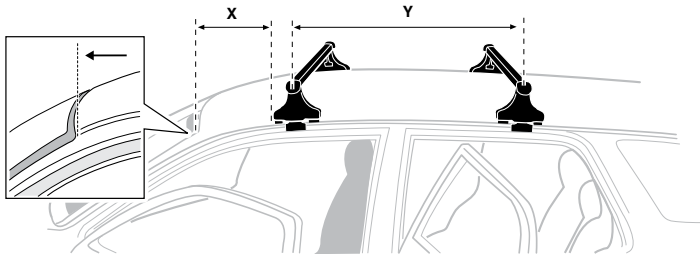

7

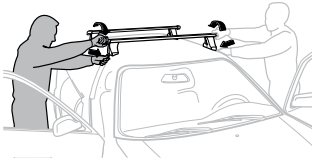

<b>GB/US</b>	Tighten alternately
<b>D</b>	Die Schrauben abwechselnd anziehen
<b>F</b>	Serrer alternativement chaque côté
<b>NL</b>	Afwisselend aan de linker- en de rechterkant aandraaien
<b>I</b>	Alternare il serraggio delle viti
<b>E</b>	Apertar alternativamente
<b>PT</b>	Aperte alternadamente
<b>S</b>	Dra åt växelvis
<b>FIN</b>	Kierrä vuorotellen
<b>EST</b>	Pinguldage vaheldumisi
<b>LAT</b>	Pielveiciet pamišus
<b>LIT</b>	Užsukinėkite pakaitomis
<b>PL</b>	Śruby dokręcaj naprzemiennie
<b>RU</b>	Затягивайте попеременно

<b>CZ</b>	Pokręťta bagažníka dokręcaj naprzemiennie.
<b>SK</b>	Dofahajte striedavo
<b>SLO</b>	Privijajte izmenično.
<b>HR</b>	Naizmjenično zategnite
<b>HU</b>	Egymástól függetlenül szorítandó
<b>GR</b>	Σφιγίγεται εναλλάξ
<b>TR</b>	Dönüşümlü sıkın

**中文** 交替拧紧

**한국어** 번갈아 가며 조이십시오.

**日本語** 交互に締め付けてください。

**ไทย** ชันในแบบสลับ

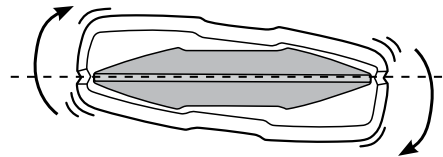
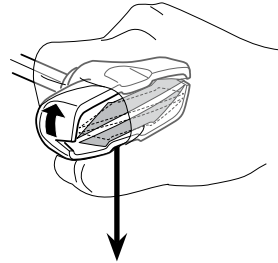
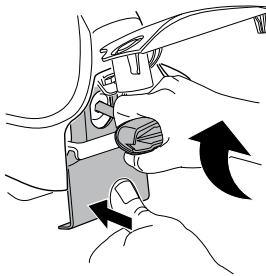
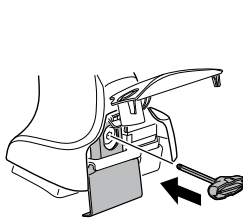

≈ 3 Nm

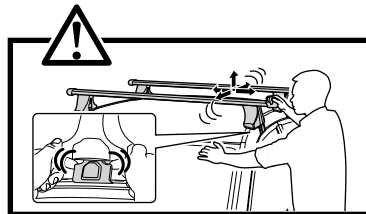
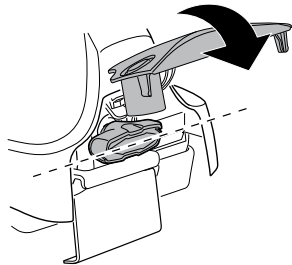

8

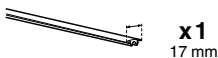



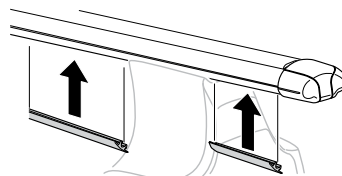

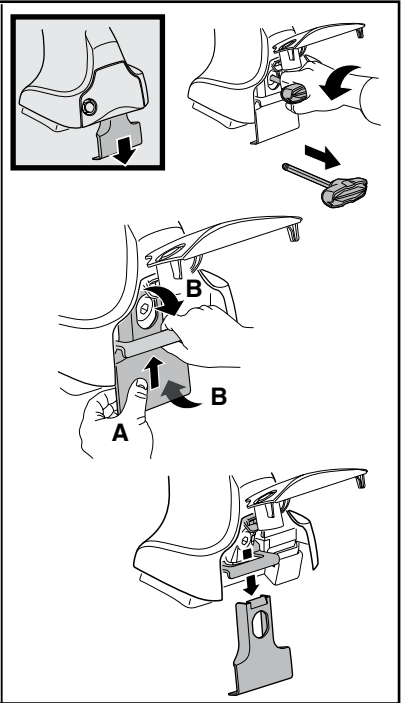
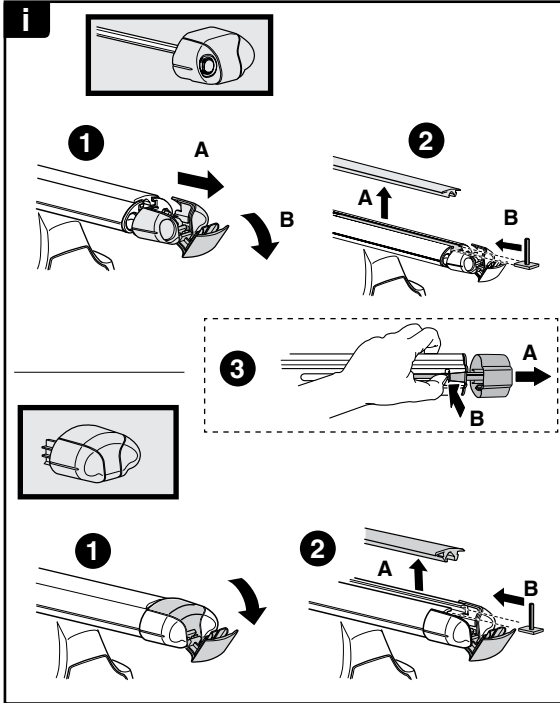
x1  
17 mm



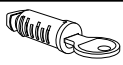

**THULE**  
SWEDEN  
**ONE  
KEY  
SYSTEM**



-  **544** (x4)
  -  **596** (x6)
  -  **588** (x8)
  -  **510** (x10)
  -  **452** (x12)
- NA  
EUR  
ASIA



WW ▶ Thule Sweden AB, Box 69, 330 33 Hillerstorp, SWEDEN  
NA ▶ Thule Inc., 42 Silvermine Road, Seymour, Connecticut 06483, USA

info@thule.com  
customer.service@thule.com

 www.thule.com