

# Kit 1554

HONDA Odyssey, 5-dr MPV, 09–

480R  
754

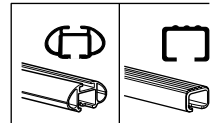
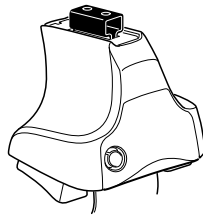

480

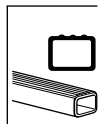
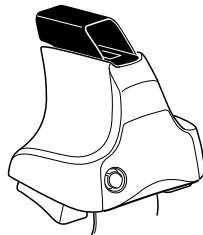

**Kit**

1

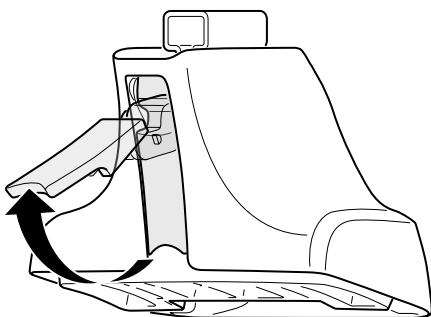
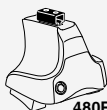

2



+

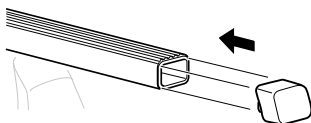
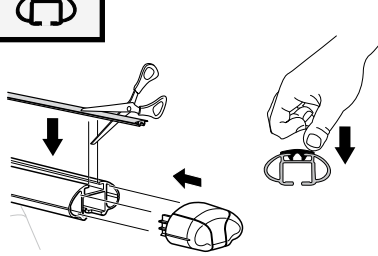
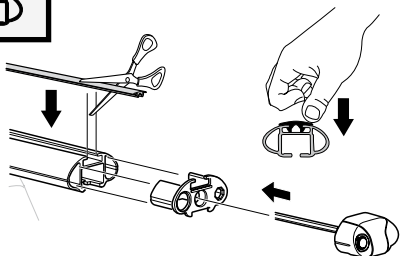
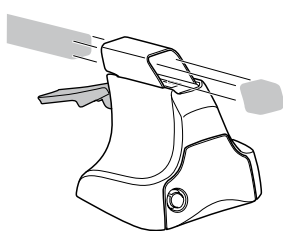
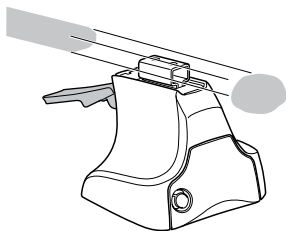

3

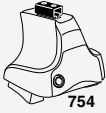

1

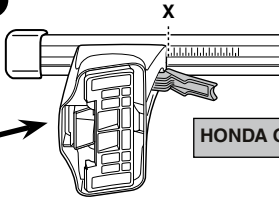
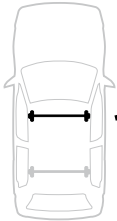

2

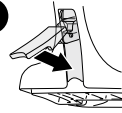

HONDA Odyssey, 5-dr MPV, 09-

X
47,5

1

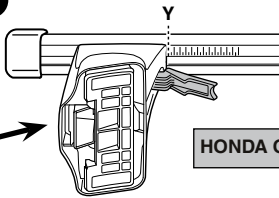

2

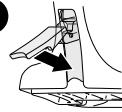

HONDA Odyssey, 5-dr MPV, 09-

Y
42

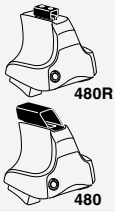

1

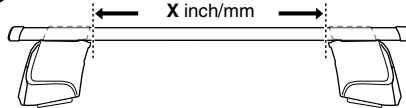

2

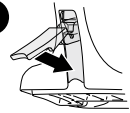

HONDA Odyssey, 5-dr MPV, 09-

X inch	X mm
44 <sup>3</sup> / <sub>8</sub> "	1126 mm

1

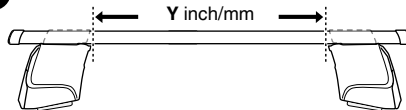

2

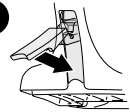

HONDA Odyssey, 5-dr MPV, 09-

Y inch	Y mm
42 <sup>1</sup> / <sub>8</sub> "	1071 mm

4



480R/754



480

HONDA Odyssey, 5-dr MPV, 09-

04



1081



FL



04



1081



FR



124



1082



RL



124



1082



RR

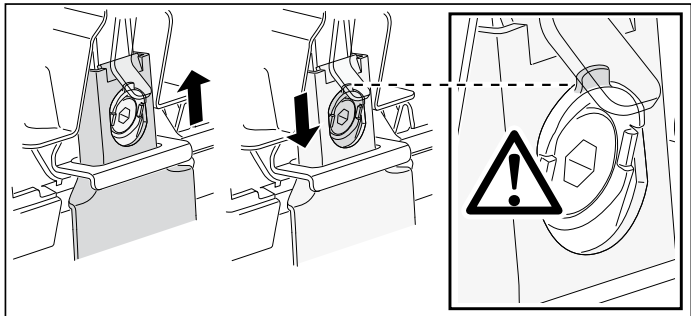
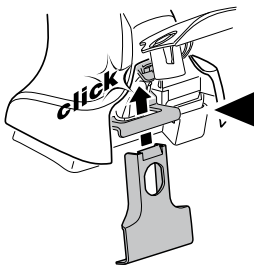
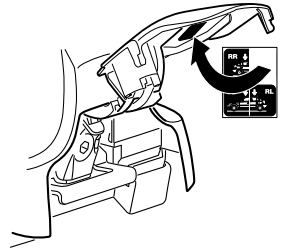
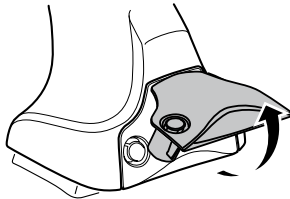
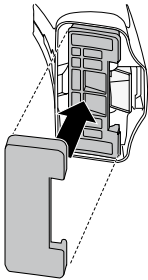

5

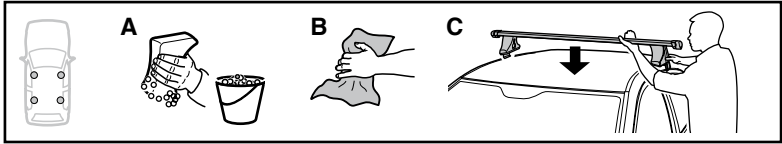

HONDA Odyssey, 5-dr MPV, 09-	X mm	Y mm	X inch	Y inch
	380 mm	715 mm	15"	28 1/8"

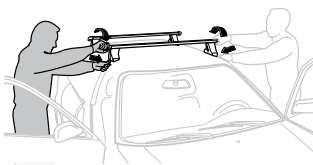
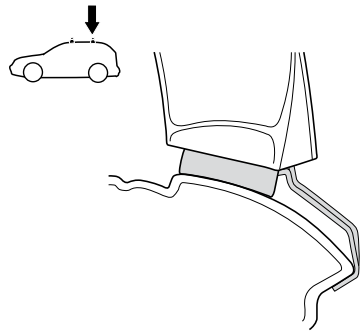
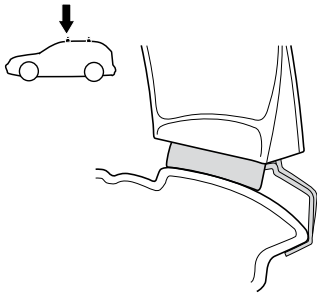
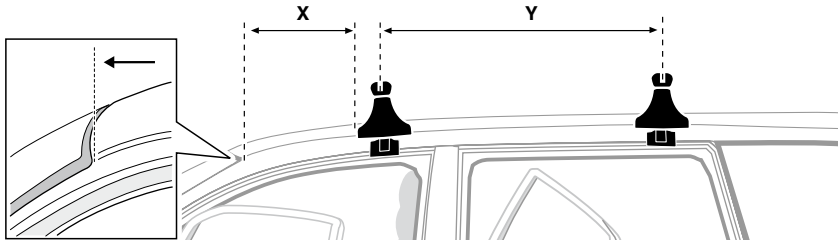

- GB/US** Tighten alternately  
**D** Die Schrauben abwechselnd anziehen  
**F** Serrer alternativement chaque côté  
**NL** Afwisselend aan de linker- en de rechterkant aandraaien  
**I** Alternare il serraggio delle viti  
**E** Apretar alternativamente  
**PT** Aperte alternadamente  
**S** Dra åt växelvis  
**FIN** Kierrä vuorotellen  
**EST** Pinguldage vaheldumisi  
**LAT** Pievelciēt pamišus  
**LIT** Užsukinėkite pakaitomis  
**PL** Śruby dokręcaj naprzemiennie  
**RU** Затягивайте попеременно

- CZ** Pokrétla bagażnika dokręcaj dokręcaj naprzemiennie.  
**SK** Dotiahujte striedavo  
**SLO** Privijajte izmenično.  
**HR** Naizmjenično zategnite  
**HU** Egymástól függetlenül szorítandó  
**GR** Σφιγγετε εναλλάξ  
**TR** Dönüşümlü sıkın

**中文** 交替拧紧

**한국어** 번갈아 가며 조이십시오.

**日本語** 交互に締め付けてください。

**ไทย** ชับในแบบสลับ

6

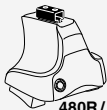

480R/754



480

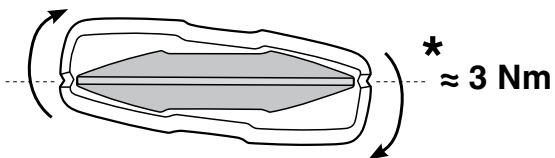
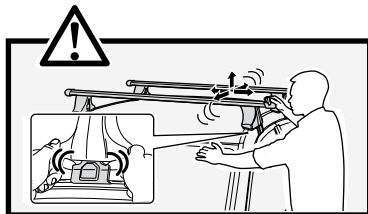
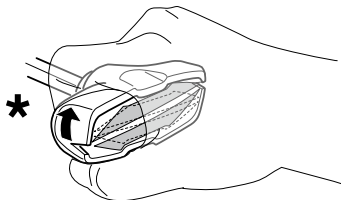
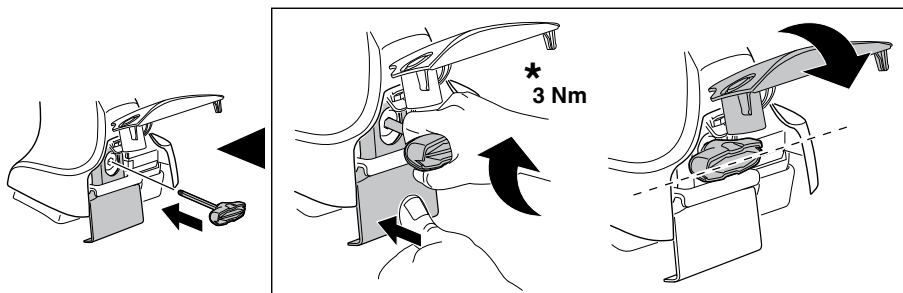

7

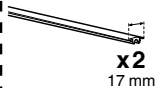

x2  
17 mm

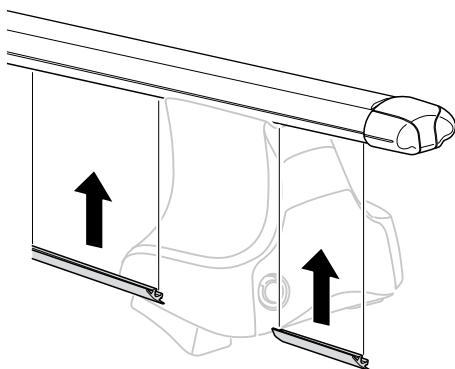

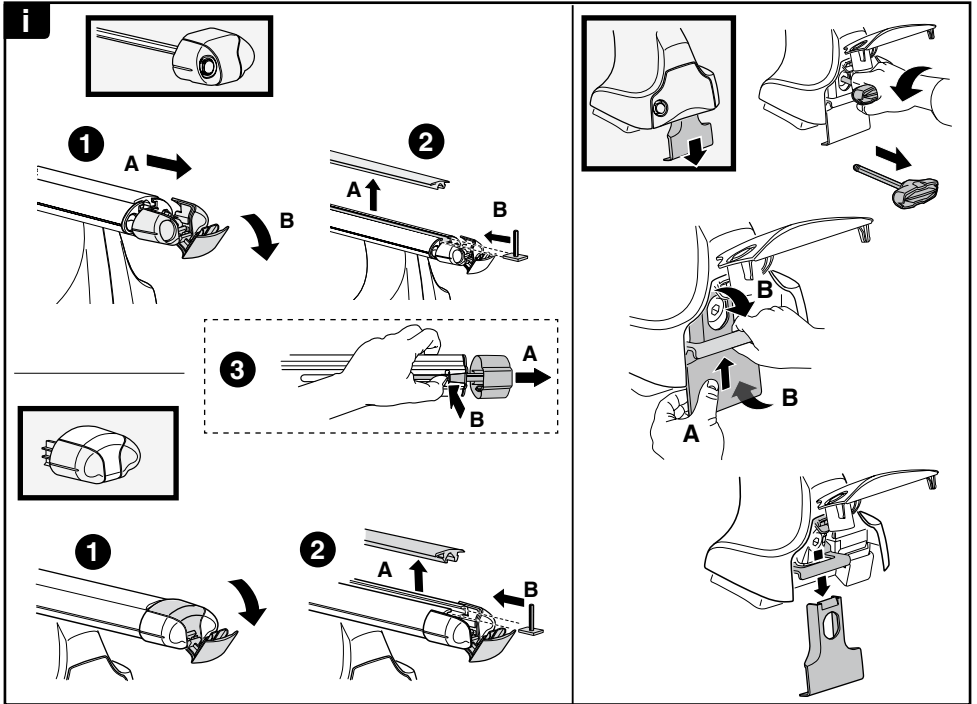
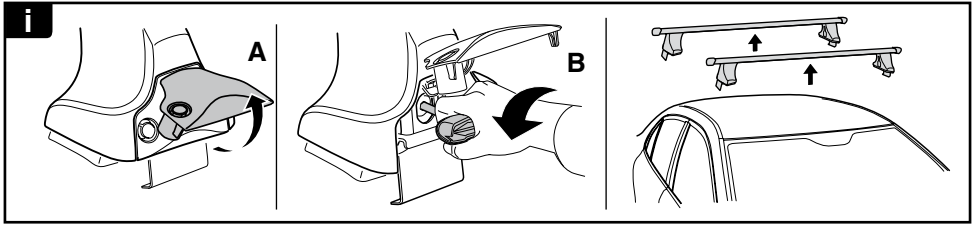

**THULE**  
SWEDEN

**ONE  
KEY  
SYSTEM**

		(x4)
		(x6)
		(x8)
NA		(x10)
EUR		(x12)
ASIA		

WW ▶ Thule Sweden AB, Box 69, 330 33 Hillerstorp, SWEDEN  
 NA ▶ Thule Inc., 42 Silvermine Road, Seymour, Connecticut 06483, USA

info@thule.com  
 customer.service@thule.com

www.thule.com