

# 1

## Kit 145181

TOYOTA Prius, 5-dr Hatchback, 04-08 / \*04-09

\*North America



ISO 11154-E

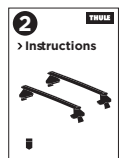
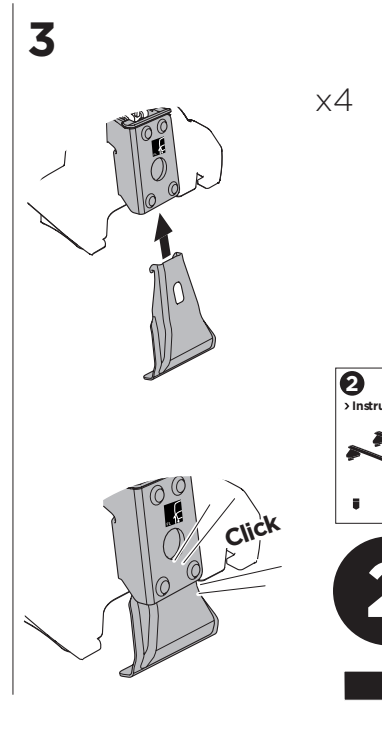
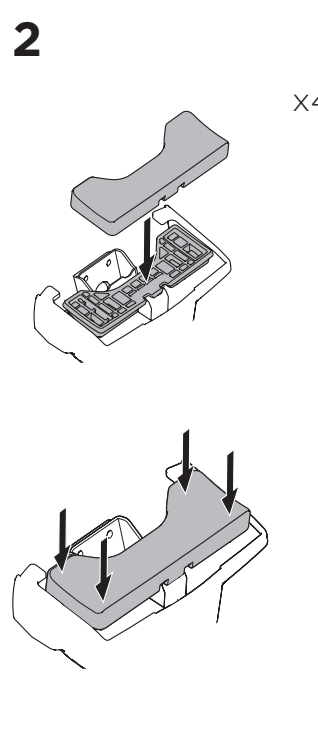
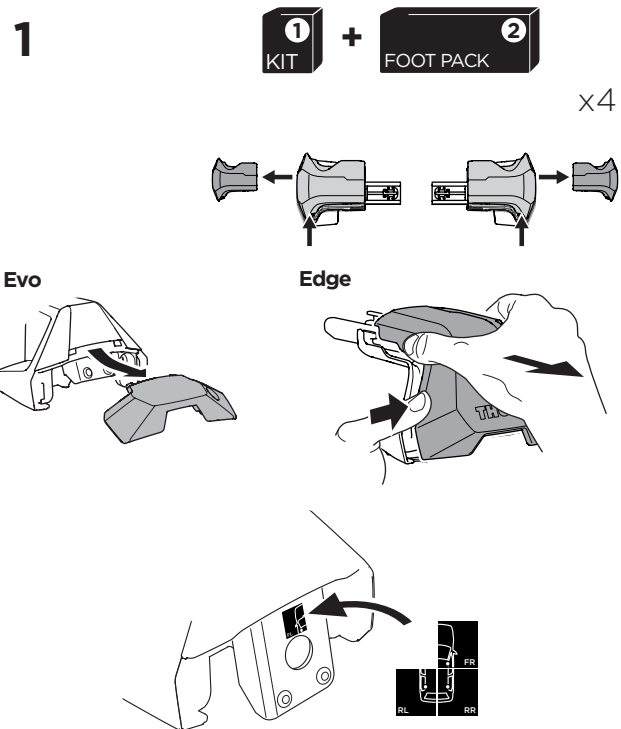
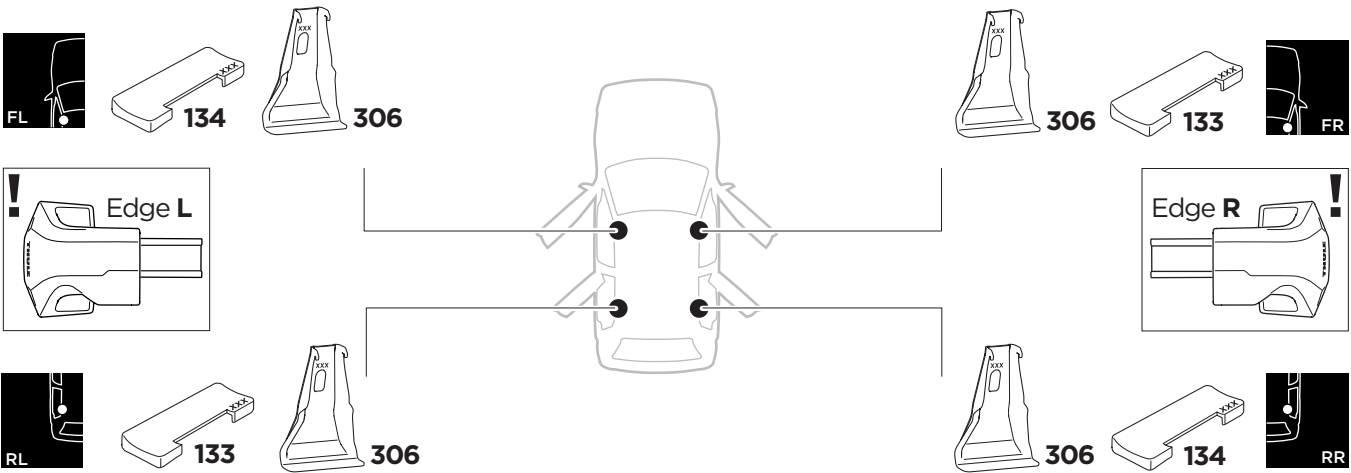
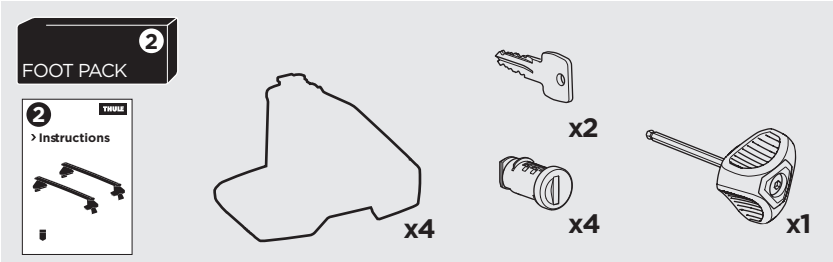
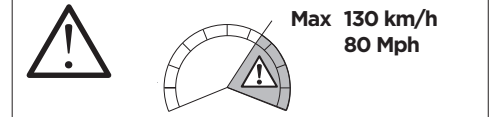
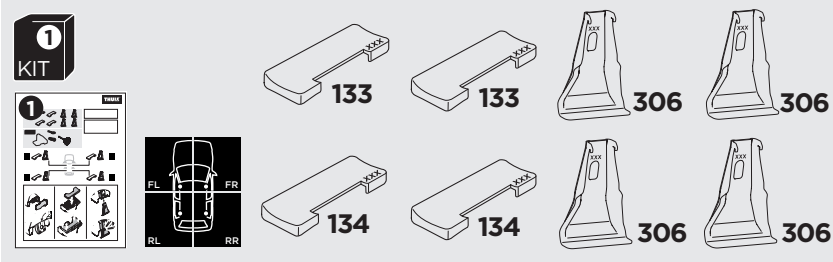



THULE WingBar Evo	THULE WingBar Edge	THULE WingBar	THULE SquareBar Evo	<b>Evo X (scale)</b>	<b>Edge X (scale)</b>
<b>TOYOTA Prius, 5-dr Hatchback, 04-08/*04-09</b>				<b>41</b>	<b>O</b>
THULE ProBar Evo	THULE SlideBar Evo				<b>X (mm/inch)</b>
<b>TOYOTA Prius, 5-dr Hatchback, 04-08/*04-09</b>				<b>1061 mm / 41 3/4"</b>	



THULE WingBar Evo	THULE WingBar Edge	THULE WingBar	THULE SquareBar Evo	<b>Evo Y (scale)</b>	<b>Edge Y (scale)</b>
<b>TOYOTA Prius, 5-dr Hatchback, 04-08/*04-09</b>				<b>39</b>	<b>A</b>
THULE ProBar Evo	THULE SlideBar Evo				<b>Y (mm/inch)</b>
<b>TOYOTA Prius, 5-dr Hatchback, 04-08/*04-09</b>				<b>1041 mm / 41"</b>	

	<b>W (mm/inch)</b>	<b>Z (mm/inch)</b>
<b>TOYOTA Prius, 5-dr Hatchback, 04-08/*04-09</b>	<b>650 mm / 25 5/8"</b>	<b>350 mm / 13 3/4"</b>

