

# 1

## Kit 145081

KIA Stinger, 5-dr Hatchback, 18-



ISO 1154-E

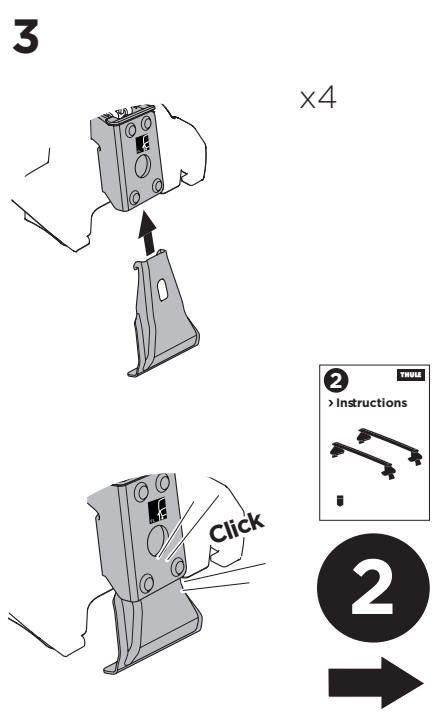
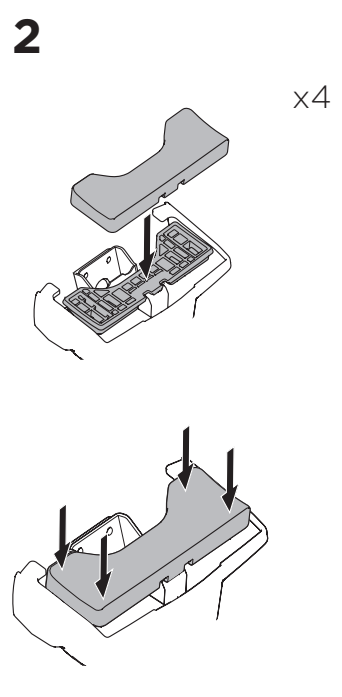
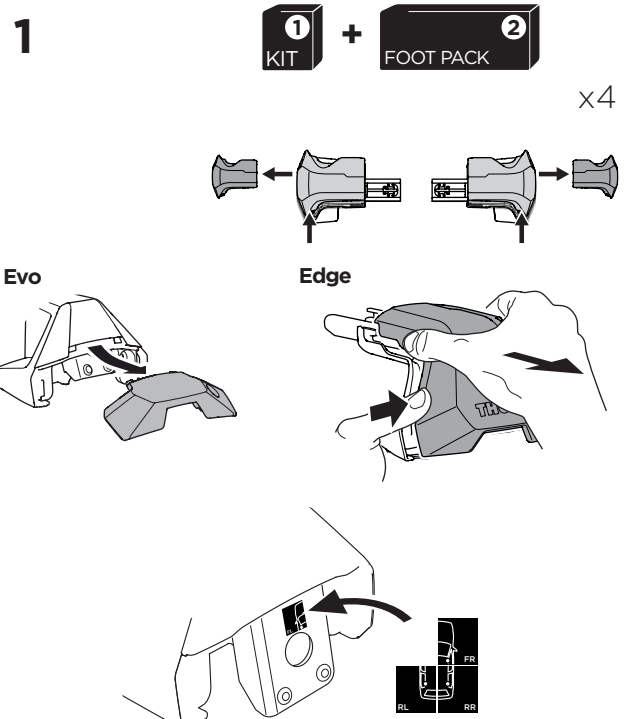
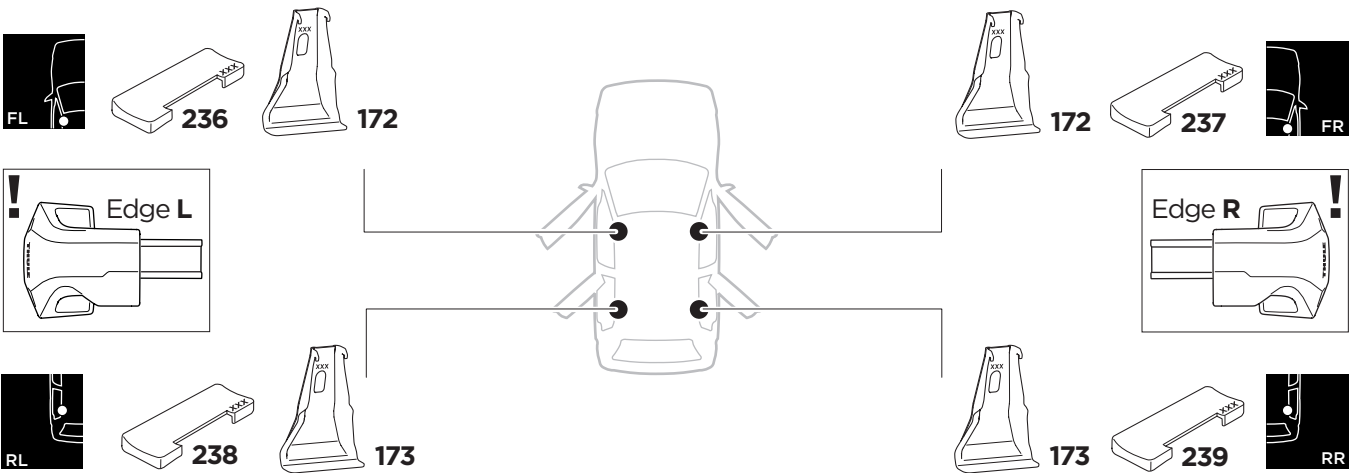
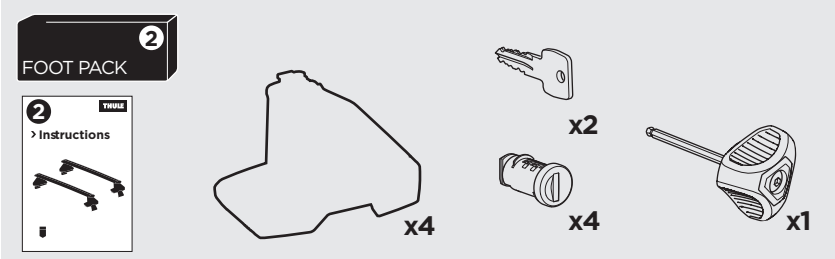
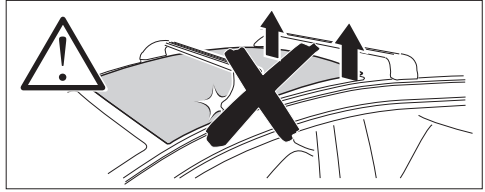
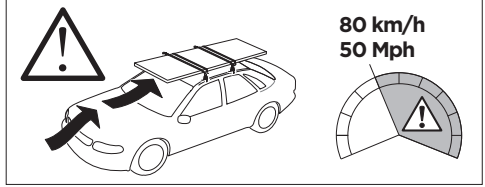
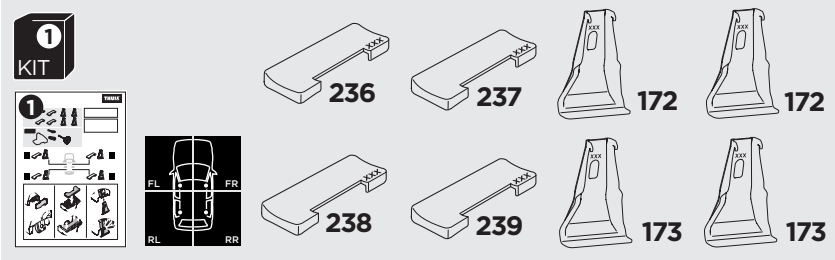

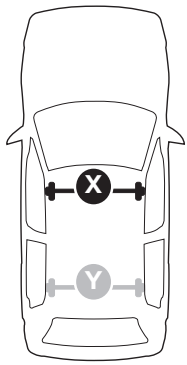

|                                         |                    |               |                     |                      |                       |
|-----------------------------------------|--------------------|---------------|---------------------|----------------------|-----------------------|
| THULE WingBar Evo                       | THULE WingBar Edge | THULE WingBar | THULE SquareBar Evo | <b>Evo X (scale)</b> | <b>Edge X (scale)</b> |
| <b>KIA Stinger, 5-dr Hatchback, 18-</b> |                    |               |                     | <b>44</b>            | <b>I</b>              |
| THULE ProBar Evo                        | THULE SlideBar Evo |               |                     |                      | <b>X (mm/inch)</b>    |
| <b>KIA Stinger, 5-dr Hatchback, 18-</b> |                    |               |                     | <b>1091 mm / 43"</b> |                       |

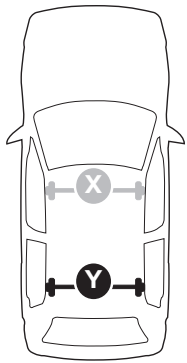

|                                         |                    |               |                     |                          |                       |
|-----------------------------------------|--------------------|---------------|---------------------|--------------------------|-----------------------|
| THULE WingBar Evo                       | THULE WingBar Edge | THULE WingBar | THULE SquareBar Evo | <b>Evo Y (scale)</b>     | <b>Edge Y (scale)</b> |
| <b>KIA Stinger, 5-dr Hatchback, 18-</b> |                    |               |                     | <b>40</b>                | <b>Q</b>              |
| THULE ProBar Evo                        | THULE SlideBar Evo |               |                     |                          | <b>Y (mm/inch)</b>    |
| <b>KIA Stinger, 5-dr Hatchback, 18-</b> |                    |               |                     | <b>1051 mm / 41 3/8"</b> |                       |

|                                         |                         |                    |
|-----------------------------------------|-------------------------|--------------------|
|                                         | <b>W (mm/inch)</b>      | <b>Z (mm/inch)</b> |
| <b>KIA Stinger, 5-dr Hatchback, 18-</b> | <b>700 mm / 27 1/2"</b> | <b>230 mm / 9"</b> |

