

# 1

## Kit 145029

TOYOTA Prius, 5-dr Hatchback, 16-



ISO 11154-E

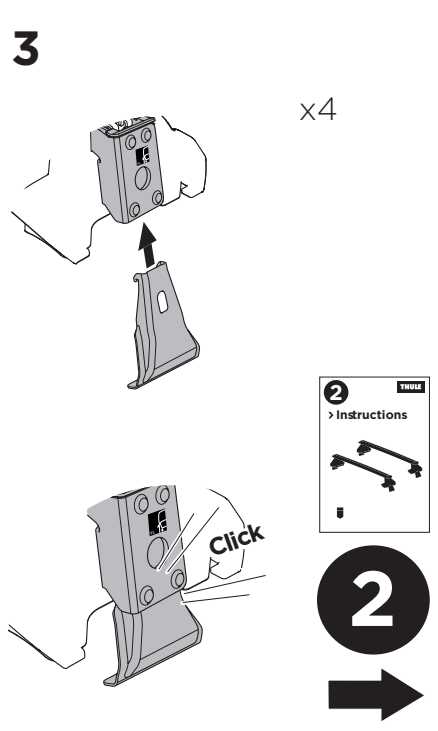
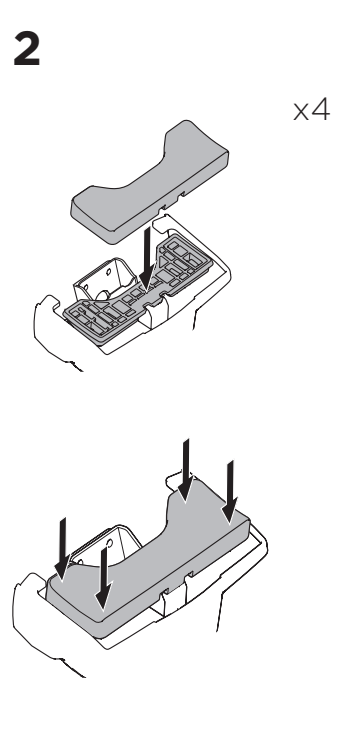
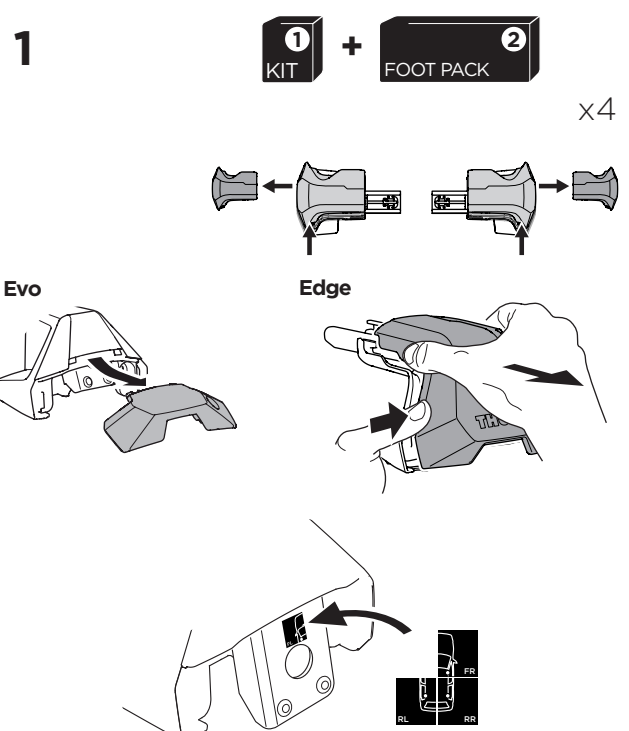
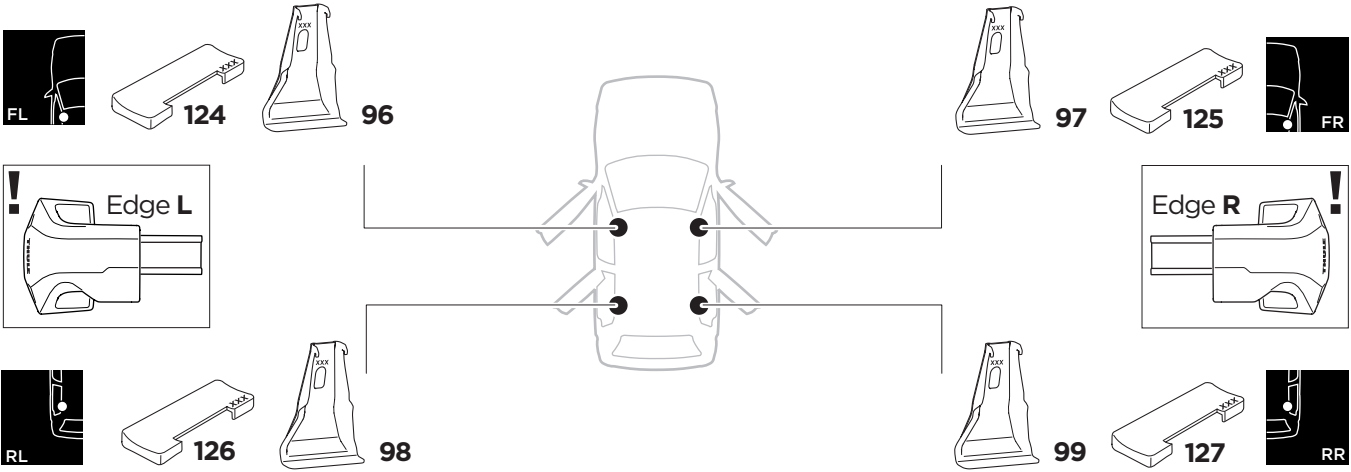
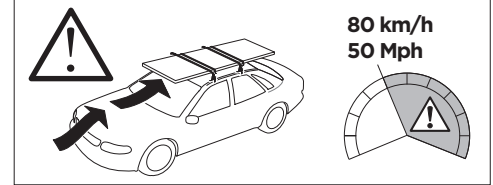
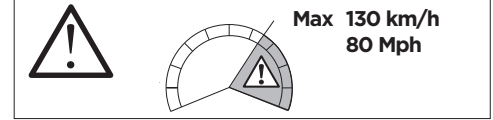
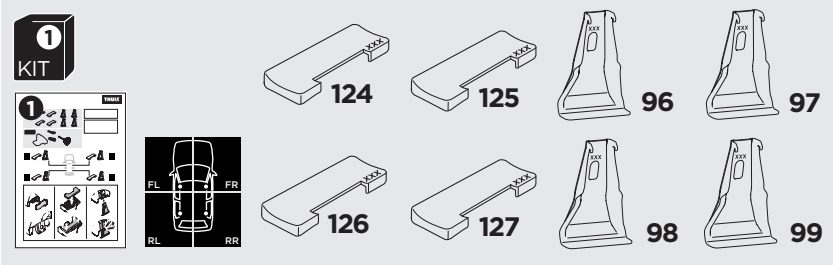



THULE WingBar Evo	THULE WingBar Edge	THULE WingBar	THULE SquareBar Evo	<b>Evo X (scale)</b>	<b>Edge X (scale)</b>
<b>TOYOTA Prius, 5-dr Hatchback, 16-</b>				<b>43</b>	<b>K</b>

THULE ProBar Evo	THULE SlideBar Evo	<b>X (mm/inch)</b>		
<b>TOYOTA Prius, 5-dr Hatchback, 16-</b>		<b>1081 mm / 42 1/2"</b>		



THULE WingBar Evo	THULE WingBar Edge	THULE WingBar	THULE SquareBar Evo	<b>Evo Y (scale)</b>	<b>Edge Y (scale)</b>
<b>TOYOTA Prius, 5-dr Hatchback, 16-</b>				<b>33</b>	<b>M</b>

THULE ProBar Evo	THULE SlideBar Evo	<b>Y (mm/inch)</b>		
<b>TOYOTA Prius, 5-dr Hatchback, 16-</b>		<b>981 mm / 38 5/8"</b>		

	<b>W (mm/inch)</b>	<b>Z (mm/inch)</b>
<b>TOYOTA Prius, 5-dr Hatchback, 16-</b>	<b>770 mm / 30 3/8"</b>	<b>180 mm / 7 1/8"</b>

