

1

Kit 145005

MINI (F55), 5-dr Hatchback, 14-

ISO 11154-E

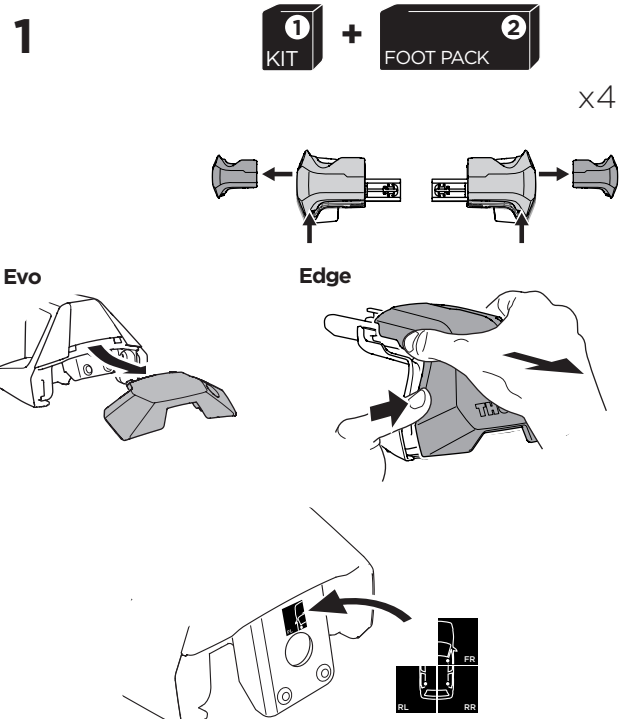
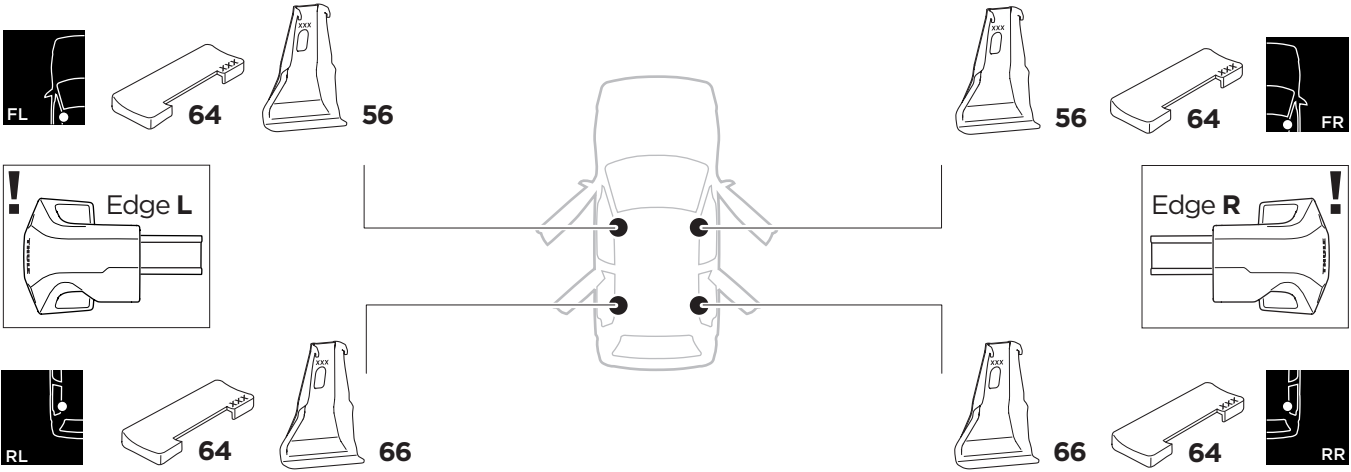
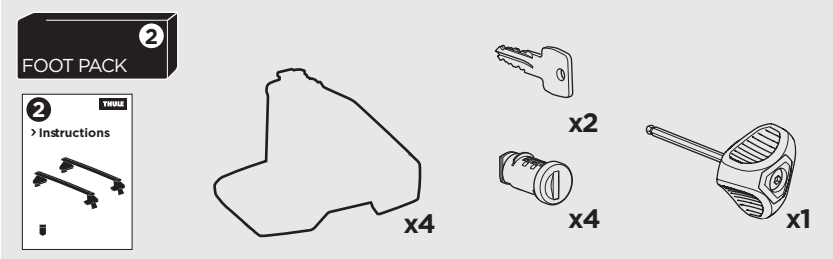
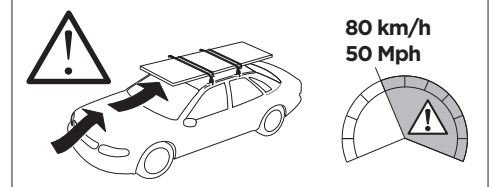
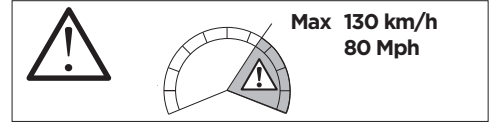
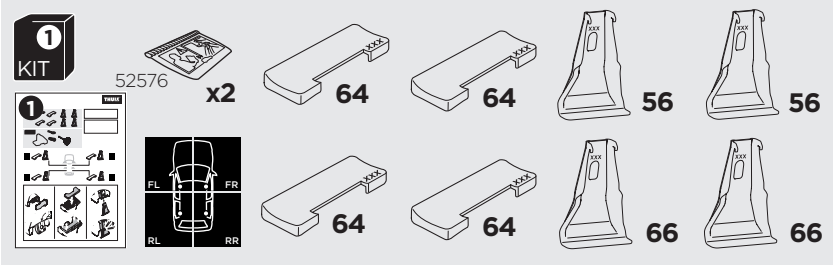



| | | | | | |
|--|--------------------|---------------|---------------------|----------------------|-----------------------|
| THULE WingBar Evo | THULE WingBar Edge | THULE WingBar | THULE SquareBar Evo | Evo X (scale) | Edge X (scale) |
| MINI (F55), 5-dr Hatchback, 14- | | | | 28 | E |

| | | | | |
|--|--------------------|-------------------------|--|--|
| THULE ProBar Evo | THULE SlideBar Evo | X (mm/inch) | | |
| MINI (F55), 5-dr Hatchback, 14- | | 931 mm / 36 5/8" | | |

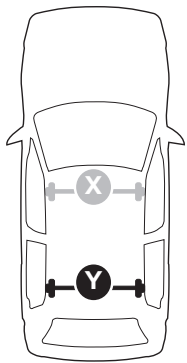

| | | | | | |
|--|--------------------|---------------|---------------------|----------------------|-----------------------|
| THULE WingBar Evo | THULE WingBar Edge | THULE WingBar | THULE SquareBar Evo | Evo Y (scale) | Edge Y (scale) |
| MINI (F55), 5-dr Hatchback, 14- | | | | 26,5 | H |

| | | | | |
|--|--------------------|-------------------------|--|--|
| THULE ProBar Evo | THULE SlideBar Evo | Y (mm/inch) | | |
| MINI (F55), 5-dr Hatchback, 14- | | 916 mm / 36 1/8" | | |

| | | |
|--|-------------------------|-------------------------|
| | W (mm/inch) | Z (mm/inch) |
| MINI (F55), 5-dr Hatchback, 14- | 700 mm / 27 1/2" | 315 mm / 12 3/8" |

