

# 1

## Kit 145004

MERCEDES X-Class, 4-dr Double Cab, 18-  
 NISSAN Navara (D23), 4-dr Double Cab, 15-  
 NISSAN NP300 (D23), 4-dr Double Cab, 15-  
 RENAULT Alaskan, 4-dr Double Cab, 18-



ISO 11154-E

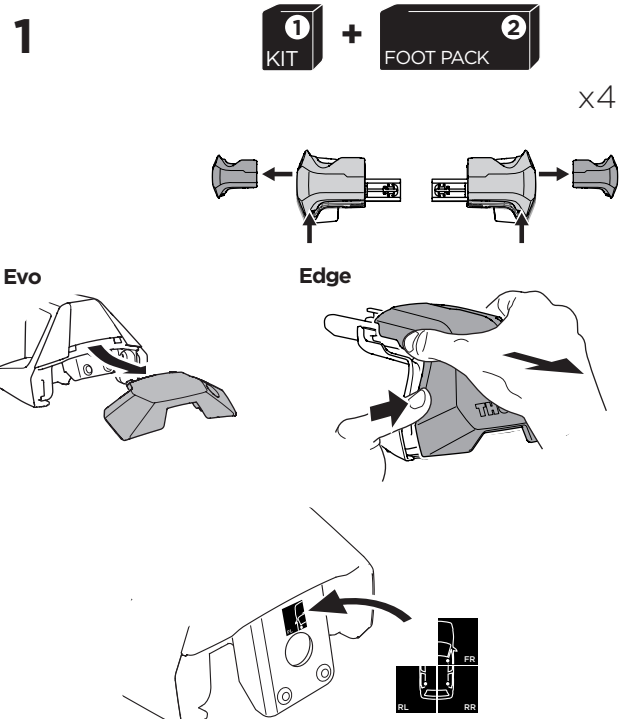
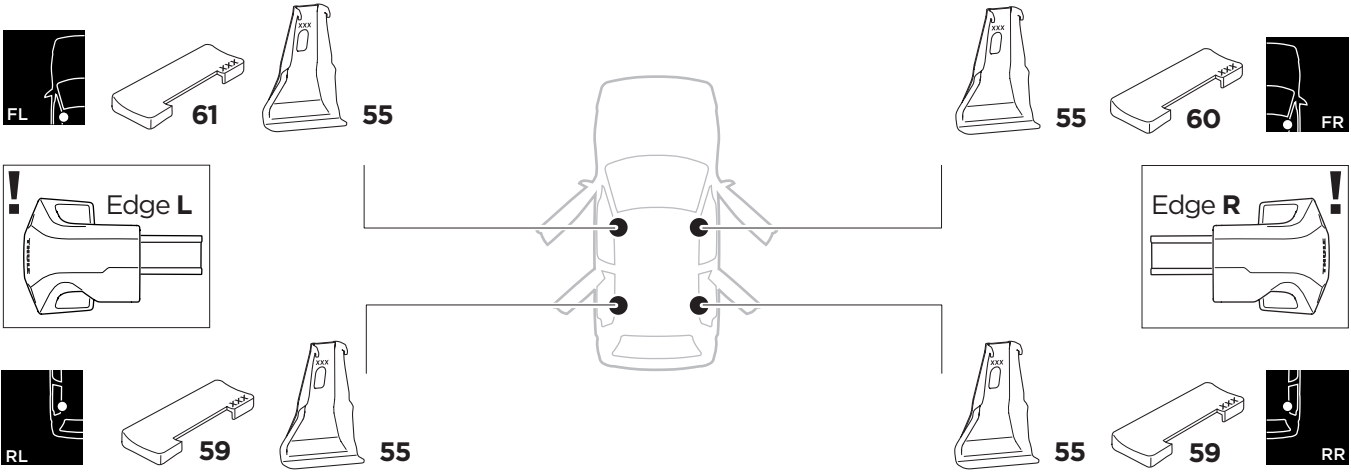
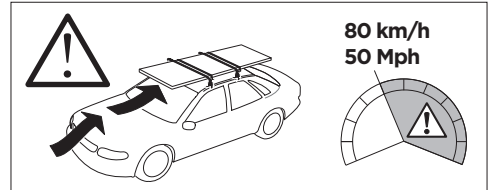
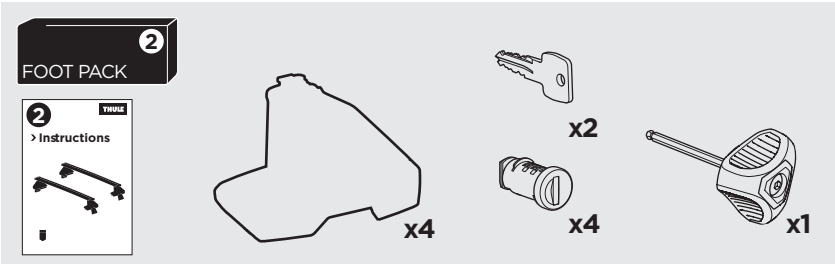
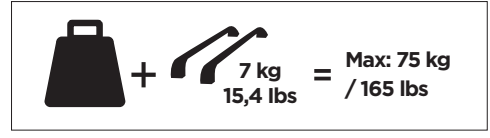
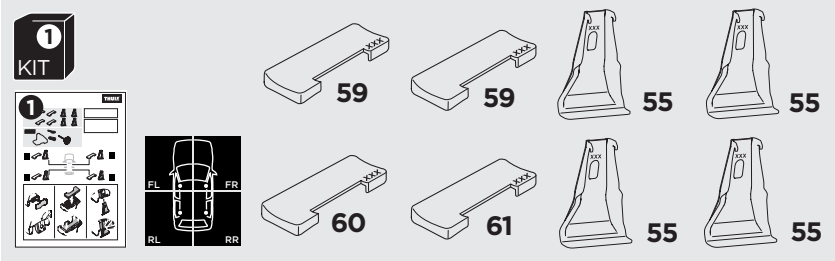

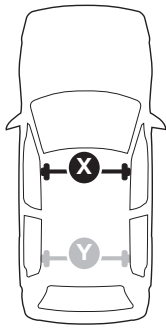

| THULE WingBar Evo                         | THULE WingBar Edge | THULE WingBar | THULE SquareBar Evo | Evo X (scale) | Edge X (scale) |
|---|--------------------|---------------|---------------------|---------------|----------------|
| MERCEDES X-Class, 4-dr Double Cab, 18-    |                    |               |                     | 51,5          | L              |
| NISSAN Navara (D23), 4-dr Double Cab, 15- |                    |               |                     | 46,5          | D              |
| NISSAN NP300 (D23), 4-dr Double Cab, 15-  |                    |               |                     | 46,5          | D              |
| RENAULT Alaskan, 4-dr Double Cab, 18-     |                    |               |                     | 46,5          | D              |

| THULE ProBar Evo                          | THULE SlideBar Evo | X (mm/inch)       |
|---|--------------------|-------------------|
| MERCEDES X-Class, 4-dr Double Cab, 18-    |                    | 1166 mm / 45 7/8" |
| NISSAN Navara (D23), 4-dr Double Cab, 15- |                    | 1116 mm / 43 7/8" |
| NISSAN NP300 (D23), 4-dr Double Cab, 15-  |                    | 1116 mm / 43 7/8" |
| RENAULT Alaskan, 4-dr Double Cab, 18-     |                    | 1116 mm / 43 7/8" |

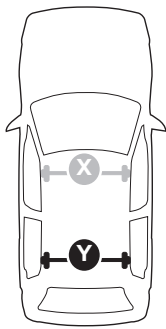

| THULE WingBar Evo                         | THULE WingBar Edge | THULE WingBar | THULE SquareBar Evo | Evo Y (scale) | Edge Y (scale) |
|---|--------------------|---------------|---------------------|---------------|----------------|
| MERCEDES X-Class, 4-dr Double Cab, 18-    |                    |               |                     | 51,5          | L              |
| NISSAN Navara (D23), 4-dr Double Cab, 15- |                    |               |                     | 46            | E              |
| NISSAN NP300 (D23), 4-dr Double Cab, 15-  |                    |               |                     | 46            | E              |
| RENAULT Alaskan, 4-dr Double Cab, 18-     |                    |               |                     | 46            | E              |

| THULE ProBar Evo                          | THULE SlideBar Evo | Y (mm/inch)       |
|---|--------------------|-------------------|
| MERCEDES X-Class, 4-dr Double Cab, 18-    |                    | 1166 mm / 45 7/8" |
| NISSAN Navara (D23), 4-dr Double Cab, 15- |                    | 1111 mm / 43 3/4" |
| NISSAN NP300 (D23), 4-dr Double Cab, 15-  |                    | 1111 mm / 43 3/4" |
| RENAULT Alaskan, 4-dr Double Cab, 18-     |                    | 1111 mm / 43 3/4" |

|   | W (mm/inch)      | Z (mm/inch)      |
|---|------------------|------------------|
| MERCEDES X-Class, 4-dr Double Cab, 18-    | 700 mm / 27 1/2" | 300 mm / 11 3/4" |
| NISSAN Navara (D23), 4-dr Double Cab, 15- | 700 mm / 27 1/2" | 300 mm / 11 3/4" |
| NISSAN NP300 (D23), 4-dr Double Cab, 15-  | 700 mm / 27 1/2" | 300 mm / 11 3/4" |
| RENAULT Alaskan, 4-dr Double Cab, 18-     | 700 mm / 27 1/2" | 300 mm / 11 3/4" |

