

Thule Rapid System Kit 1443

> Instructions

LAND ROVER Freelander 2, 5-dr SUV, 07-

LAND ROVER LR2, 5-dr SUV, *07-

*North America

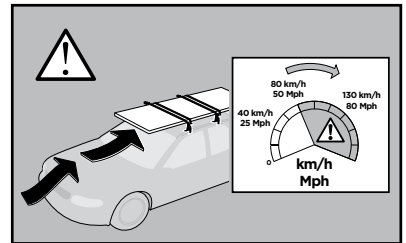
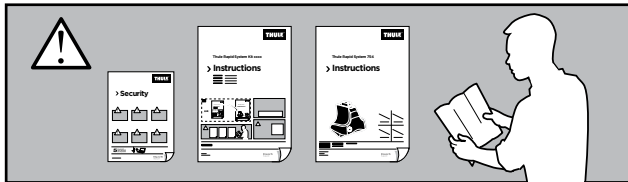
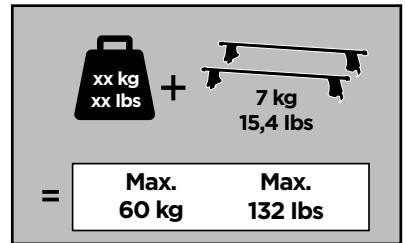
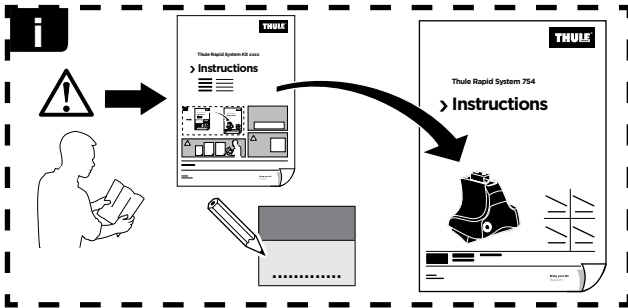

ISO 11154-E

141443

C.20120524
519-1443-02

Bring your life

thule.com



x1

225 x4

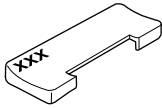

890 x4

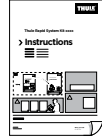

x1

1

	X (scale)	X (mm)	X (inch)
LAND ROVER Freelander 2, 5-dr SUV, 07-	45,5	1106	43 1/2
LAND ROVER LR2, 5-dr SUV, *07-	45,5	1106	43 1/2

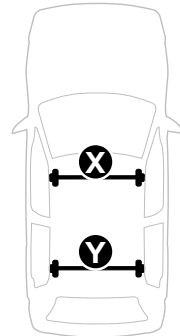
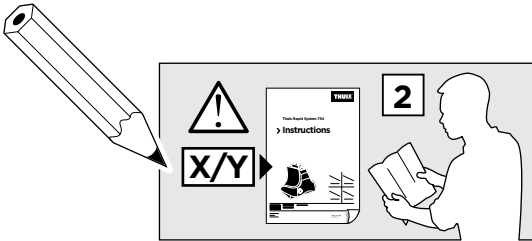

	Y (scale)	Y (mm)	Y (inch)
LAND ROVER Freelander 2, 5-dr SUV, 07-	42,5	1076	42 3/8
LAND ROVER LR2, 5-dr SUV, *07-	42,5	1076	42 3/8

2

LAND ROVER Freelander 2, 5-dr SUV, 07-
LAND ROVER LR2, 5-dr SUV, *07-

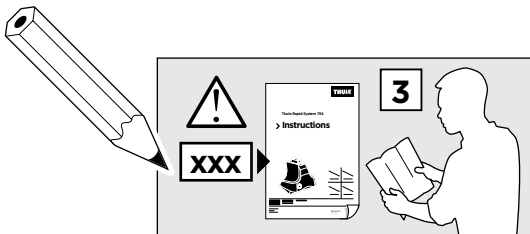
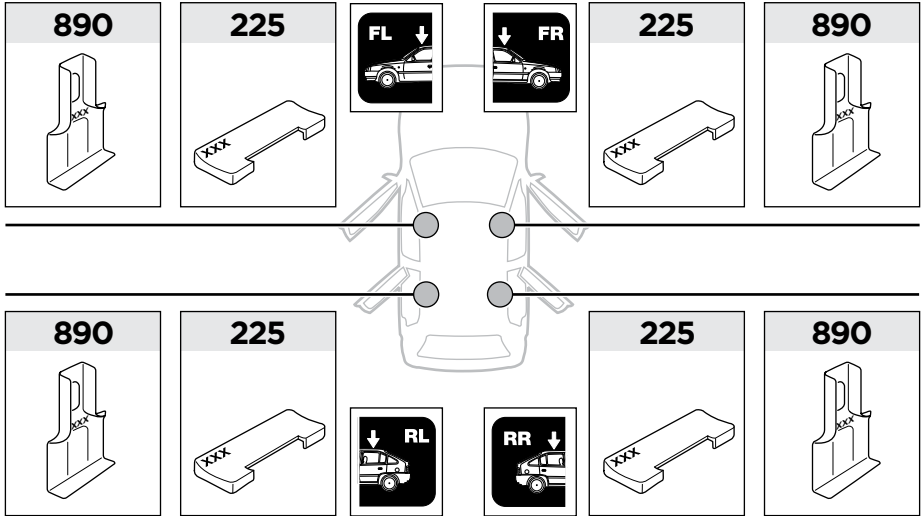

3

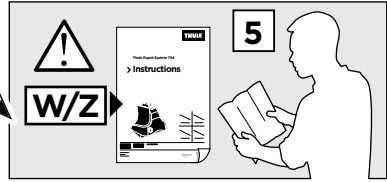
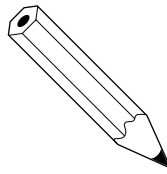

	W (mm)	Z (mm)	W (inch)	Z (inch)
LAND ROVER Freelander 2 , 5-dr SUV, 07-	310	700	12 1/4	27 1/2
LAND ROVER LR2 , 5-dr SUV, *07-	310	700	12 1/4	27 1/2

