

Kit 1423

AUDI A6, 4-dr Sedan, 04-

480R
754

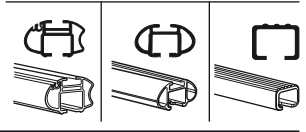
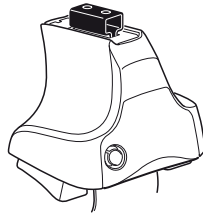

480

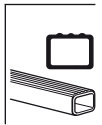
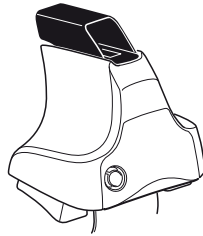

750

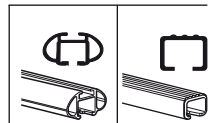
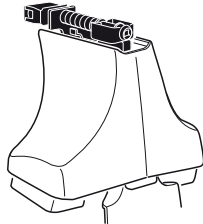

Max. 75kg
Max. 165 lbs

x1

x4

x4

x4

x4

480R/754

x1

x4

x4

x4

480

x1

x4

x4

750

x2 x2 x2 x4	x2	x2 x2 x4 x4	x2 x2	x2

836 x2

911 x2

29 x1

30 x1

259 x1

260 x1

x1

Kit

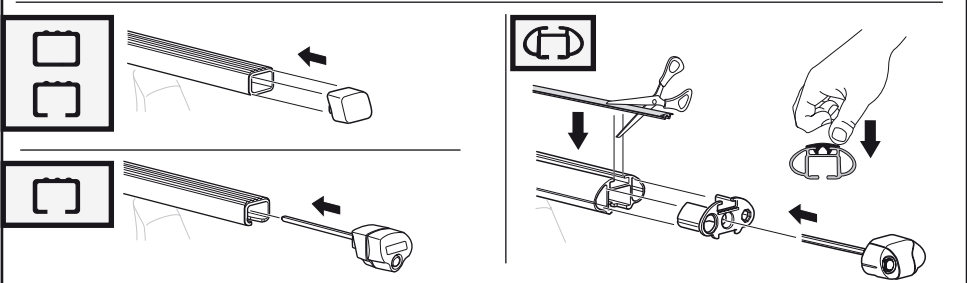
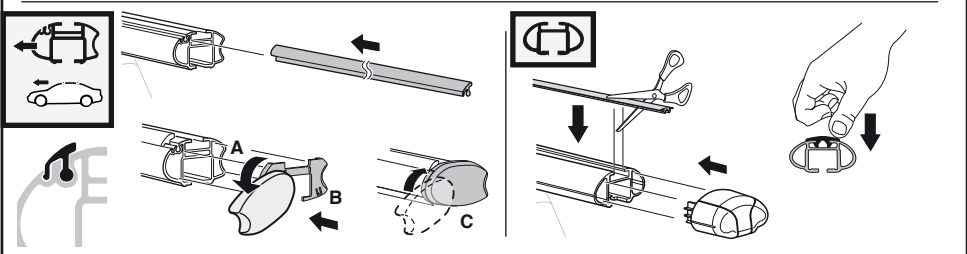
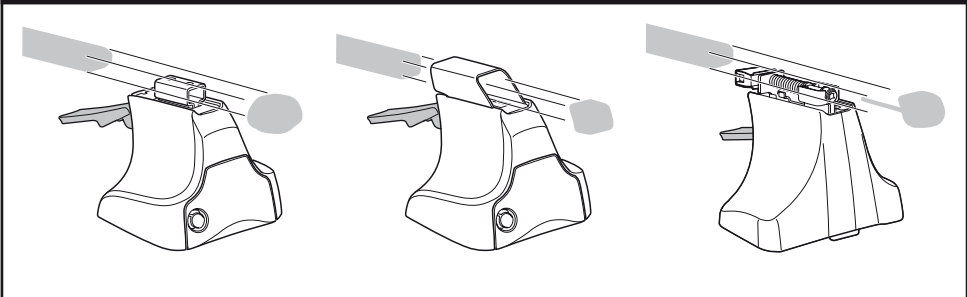
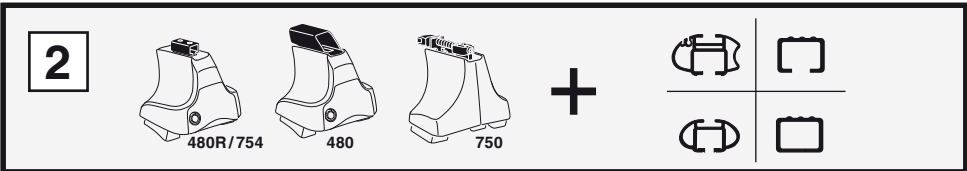
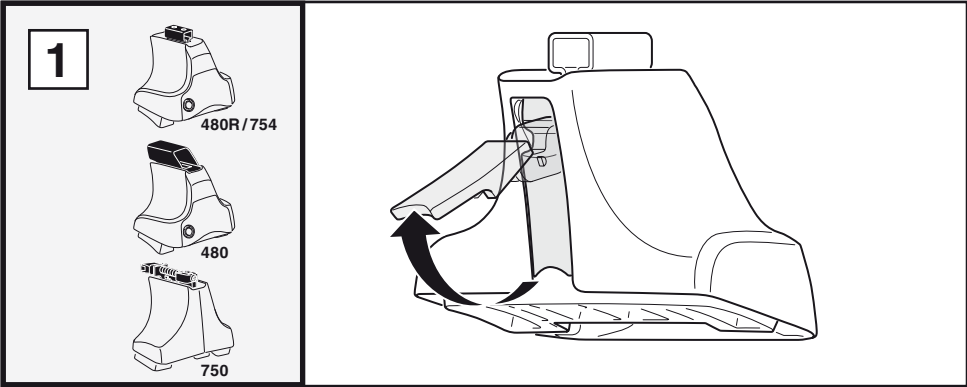

3

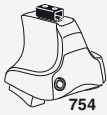

754

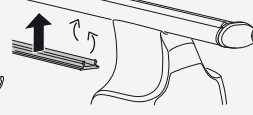
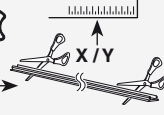

750



1

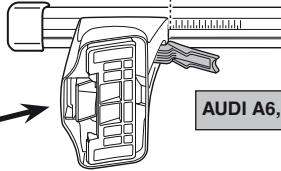

2

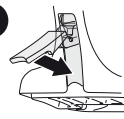

AUDI A6, 4-dr Sedan, 04-

X

36

1

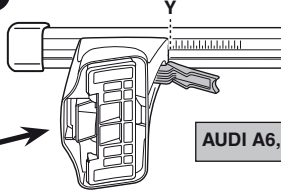

2

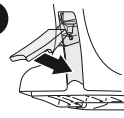

AUDI A6, 4-dr Sedan, 04-

Y

36



480R



480

1

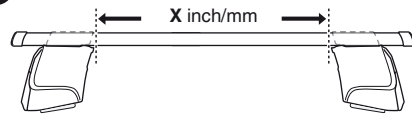

2

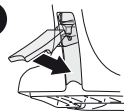

AUDI A6, 4-dr Sedan, 04-

X inch

X mm

39 3/4"

1011 mm

1

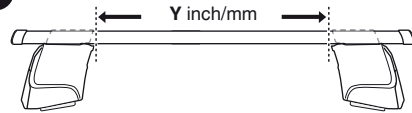

2

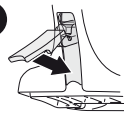

AUDI A6, 4-dr Sedan, 04-

Y inch

Y mm

39 3/4"

1011 mm

4

AUDI A6, 4-dr Sedan, 04-

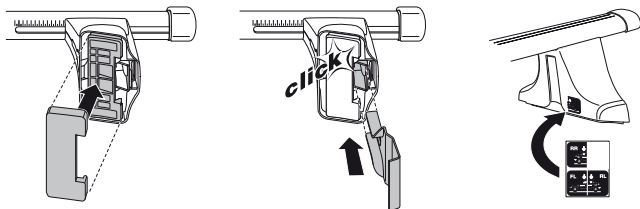
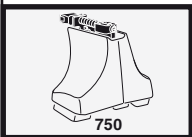
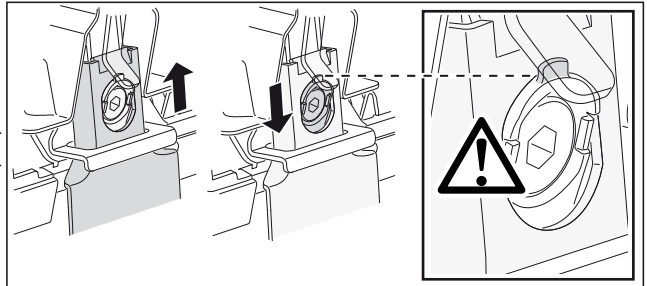
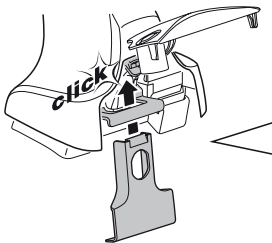
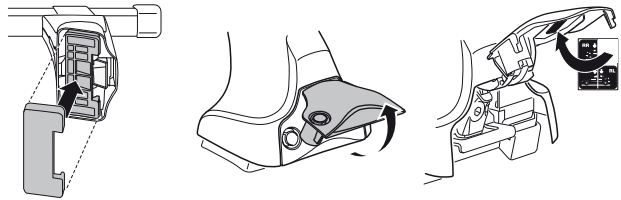
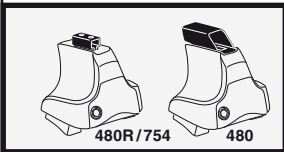
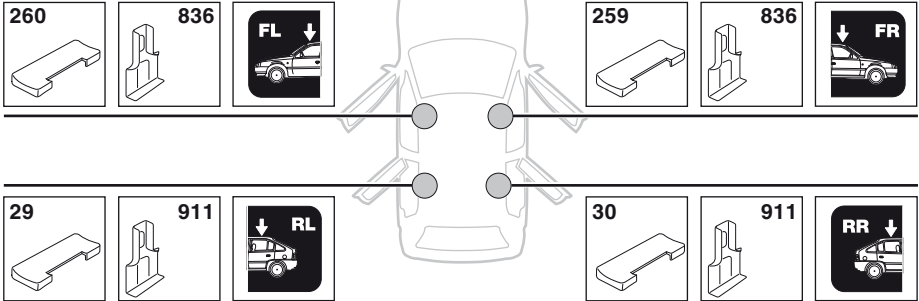

5

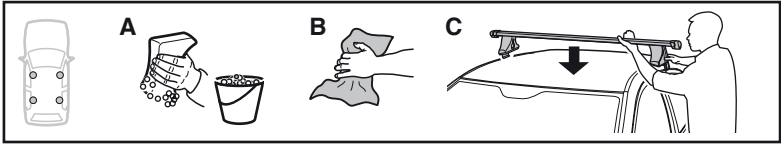

	X mm	Y mm	X inch	Y inch
AUDI A6, 4-dr Sedan, 04-	215 mm	790 mm	8 1/2"	31 1/8"

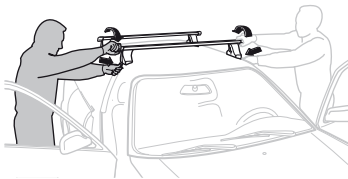
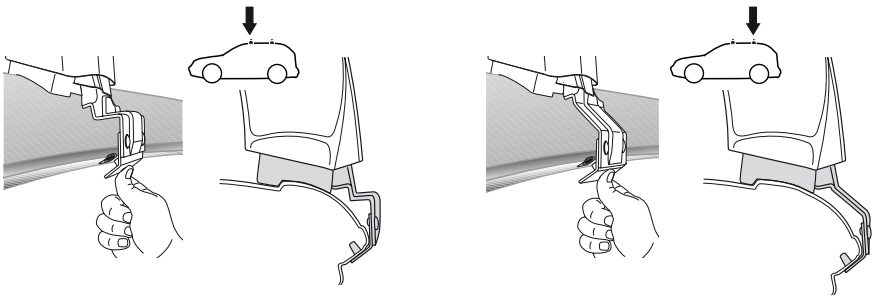
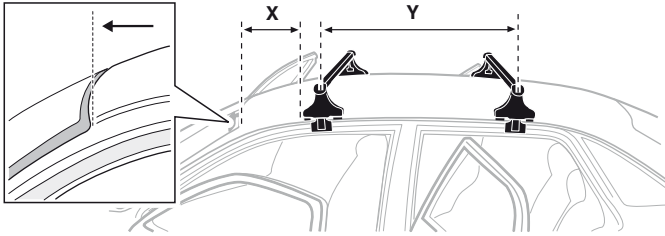

GB/US Tighten alternately

D Die Schrauben abwechselnd anziehen

F Serrer alternativement chaque côté

NL Afwisselend aan de linker- en de rechterkant aandraaien

I Alternare il serraggio delle viti

E Apretar alternativamente

PT Aperte alternadamente

S Dra åt växelvis

FIN Kierrä vuorotellen

EST Pinguldage vaheldumisi

LAT Pielieciet pamišus

LIT Užsukinėkite pakaitomis

PL Śruby dokręcaj naprzemiennie

RU Затягивайте попеременно

CZ Pokręťta bagażníka dokręcaj dokręcaj naprzemiennie.

SK Doťahujte striedavo

SLO Privijajte izmenično.

HR Naizmjenično zategnite

HU Egymástól függetlenül szorítandó

GR Σφιγγετε εναλλάξ

TR Dönüşümlü sıkın

中文 交替拧紧

한국어 번갈아 가며 조이십시오.

日本語 交互に締め付けてください。

ไทย ชั้้นโน้แบบสลับ

6



480R/754



480

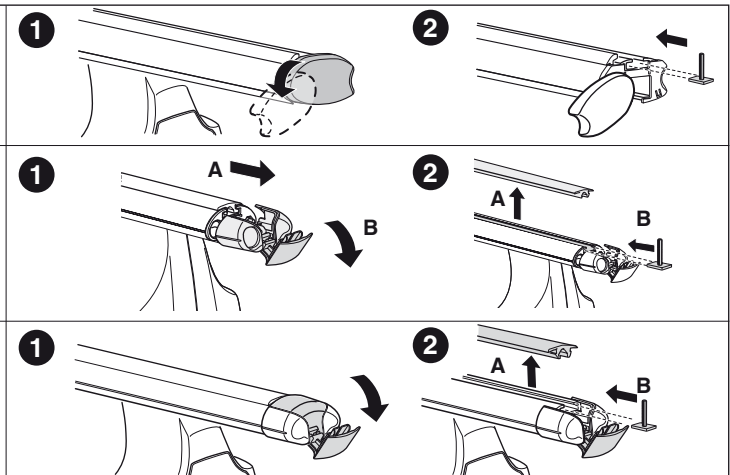
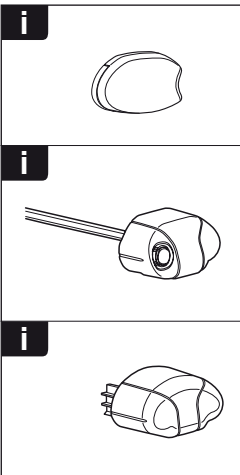
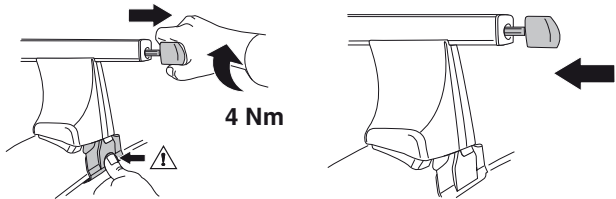
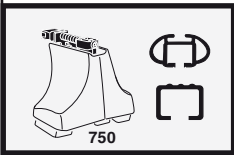
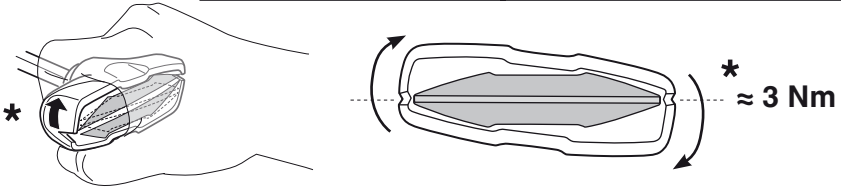
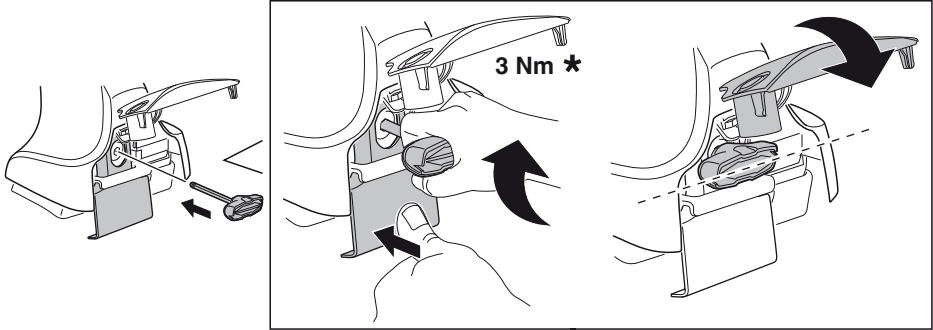

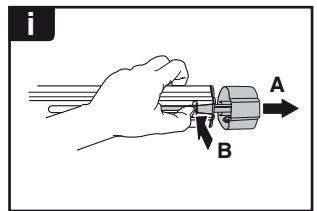
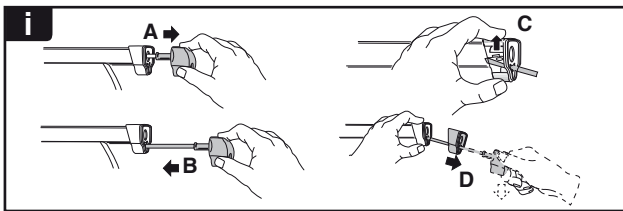
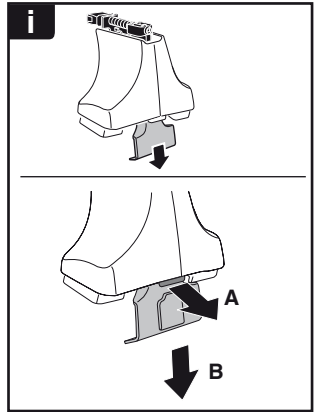
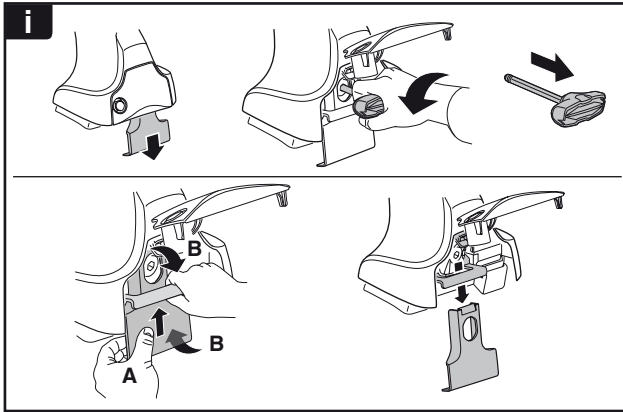
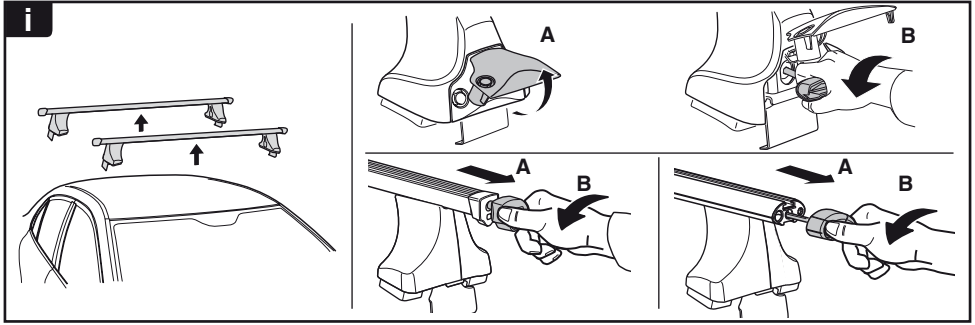

THULE
SWEDEN
**ONE
KEY
SYSTEM**

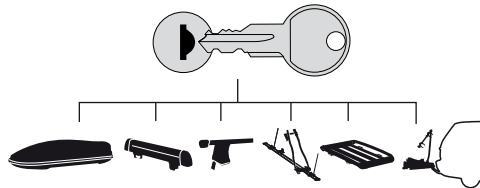

		(x4)
		(x6)
		(x8)
NA		(x10)
EUR		(x12)
ASIA		(x12)

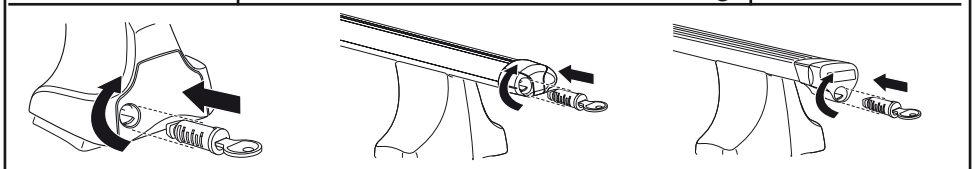

WW ▶ Thule Sweden AB, Box 69, 330 33 Hillerstorp, SWEDEN
NA ▶ Thule Inc., 42 Silvermine Road, Seymour, Connecticut 06483, USA

info@thule.com
customer.service@thule.com

www.thule.com