

Kit 1409

MITSUBISHI Outlander II, 5-dr SUV, 05–
MITSUBISHI Outlander, 5-dr SUV, *07–
*North America

480R
754

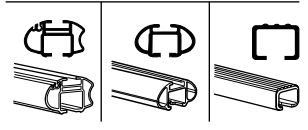
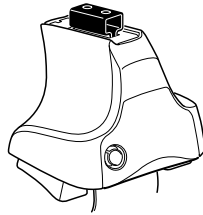

480

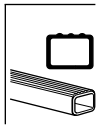
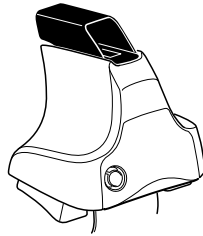

750

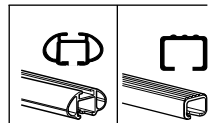
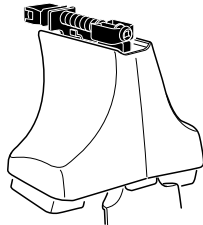

Kit

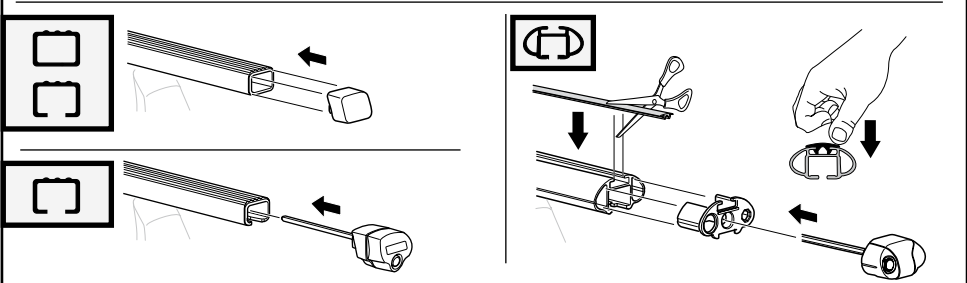
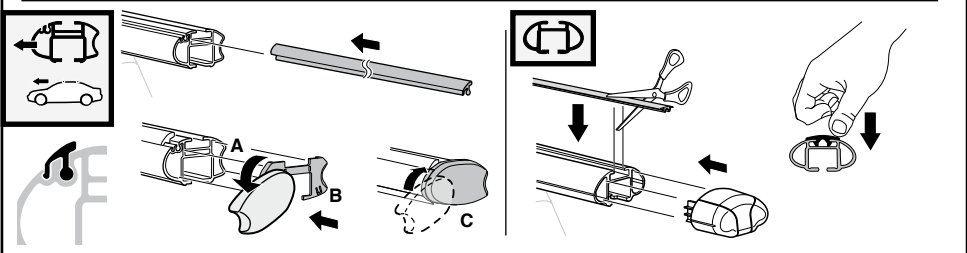
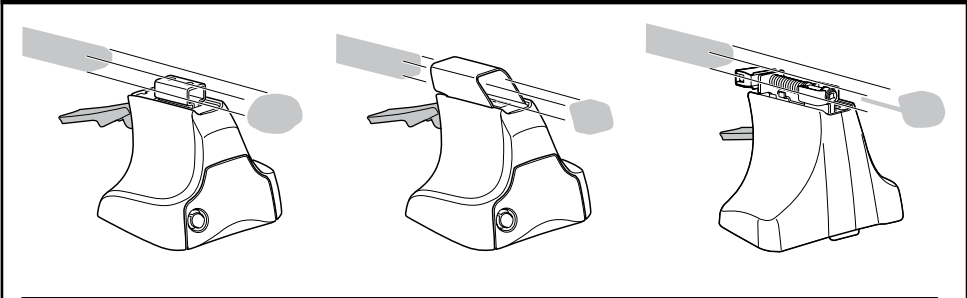
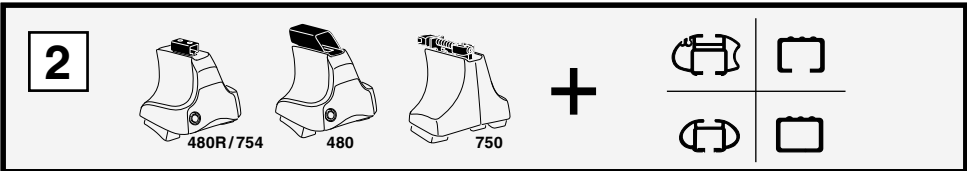
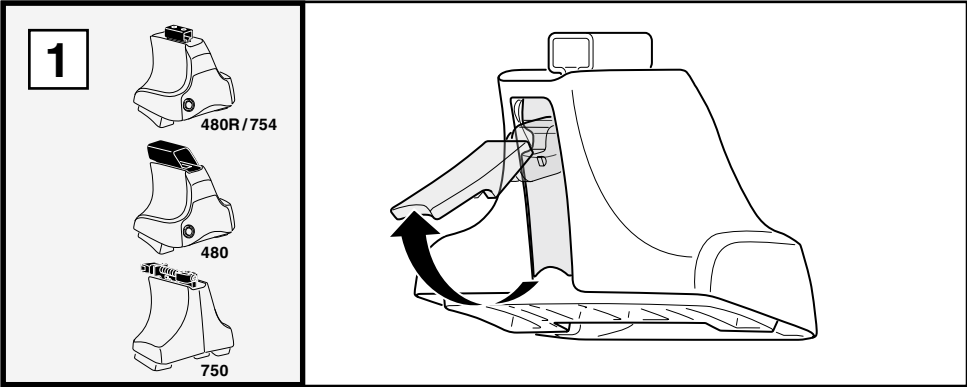

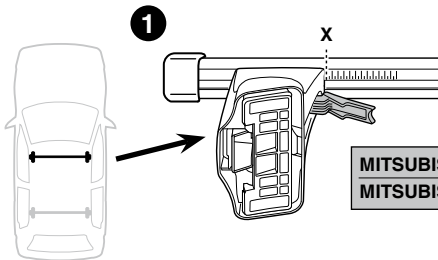

| | X |
|---|-----------|
| MITSUBISHI Outlander II, 5-dr SUV, 05- | 48 |
| MITSUBISHI Outlander, 5-dr SUV, *07- | 48 |

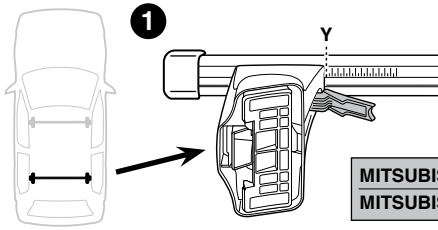
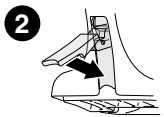

| | Y |
|---|-------------|
| MITSUBISHI Outlander II, 5-dr SUV, 05- | 43,5 |
| MITSUBISHI Outlander, 5-dr SUV, *07- | 43,5 |

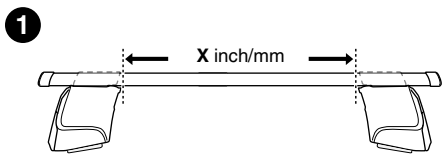
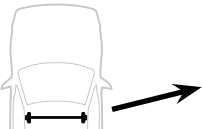
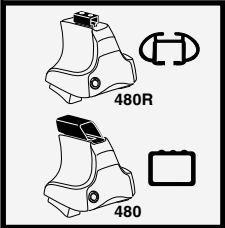
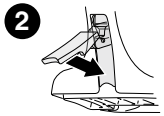

| | X inch | X mm |
|---|----------------|----------------|
| MITSUBISHI Outlander II, 5-dr SUV, 05- | 44 1/2" | 1131 mm |
| MITSUBISHI Outlander, 5-dr SUV, *07- | 44 1/2" | 1131 mm |

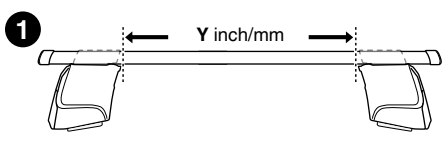
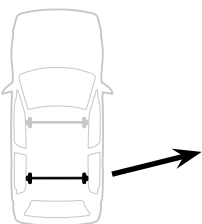
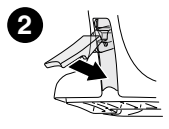

| | Y inch | Y mm |
|---|----------------|----------------|
| MITSUBISHI Outlander II, 5-dr SUV, 05- | 42 3/4" | 1086 mm |
| MITSUBISHI Outlander, 5-dr SUV, *07- | 42 3/4" | 1086 mm |

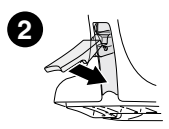

4

MITSUBISHI Outlander II, 5-dr SUV, 05-
MITSUBISHI Outlander, 5-dr SUV, *07-

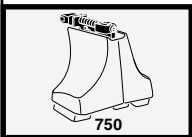
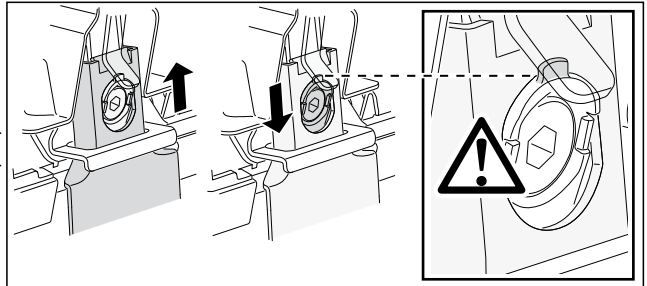
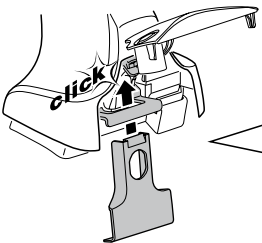
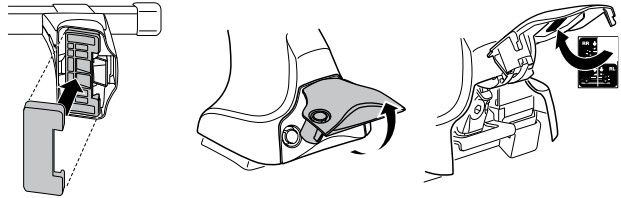
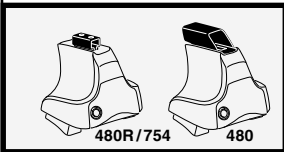
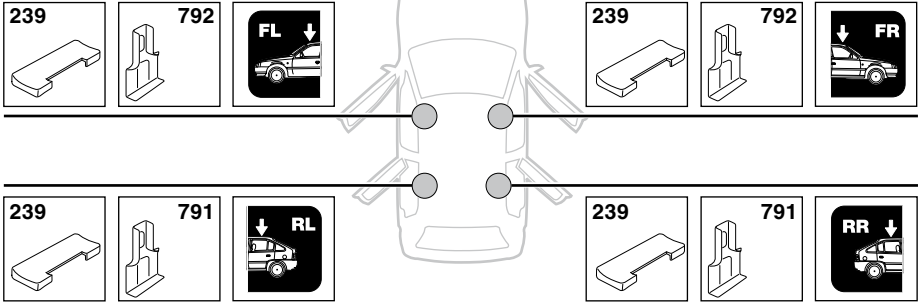

5



| | X mm | Y mm | X inch | Y inch |
|--|--------|--------|----------------------------------|----------------------------------|
| MITSUBISHI Outlander II, 5-dr SUV, 05- | 440 mm | 800 mm | 17 ³ / ₈ " | 31 ¹ / ₂ " |
| MITSUBISHI Outlander, 5-dr SUV, *07- | 440 mm | 800 mm | 17 ³ / ₈ " | 31 ¹ / ₂ " |

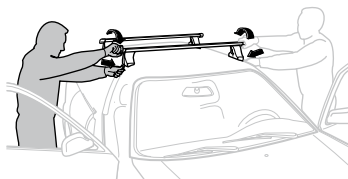
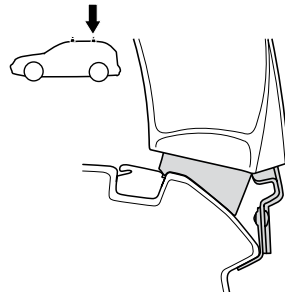
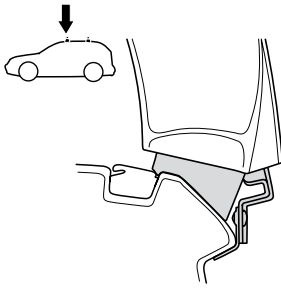
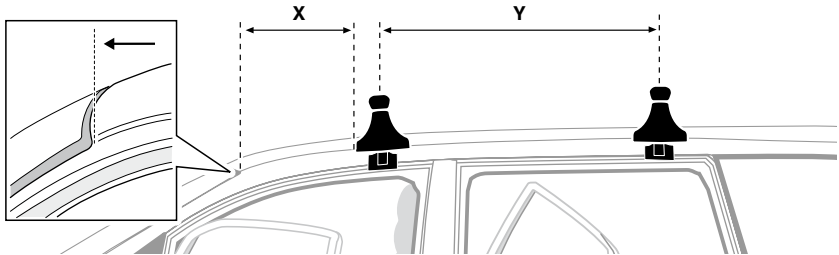

GB/US Tighten alternately

D Die Schrauben abwechselnd anziehen

F Serrer alternativement chaque côté

NL Afwisselend aan de linker- en de rechterkant aandraaien

I Alternare il serraggio delle viti

E Apretar alternativamente

PT Aperte alternadamente

S Dra åt växelvis

FIN Kierrä vuorotellen

EST Pinguldage vaheldumisi

LAT Pielieciet pamišus

LIT Užsukinėkite pakaitomis

PL Śruby dokręcaj naprzemiennie

RU Затягивайте попеременно

CZ Pokręťta bagażníka dokręcaj dokręcaj naprzemiennie.

SK Doťahujte striedavo

SLO Privijajte izmenično.

HR Naizmjenično zategnite

HU Egymástól függetlenül szorítandó

GR Σφιγγετε εναλλάξ

TR Dönüşümlü sıkın

中文 交替拧紧

한국어 번갈아 가며 조이십시오.

日本語 交互に締め付けてください。

ไทย ชันโนแบบสลับ

6



480R/754



480



*
3 Nm



*



*
≈ 3 Nm

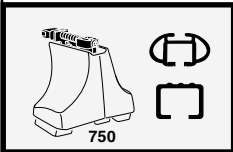

750

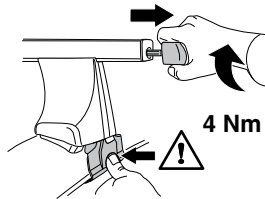

4 Nm

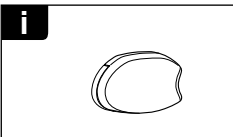
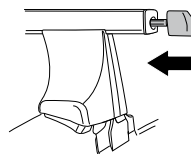

i

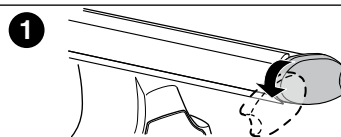

1

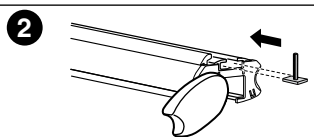

2

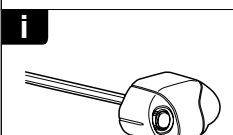

i

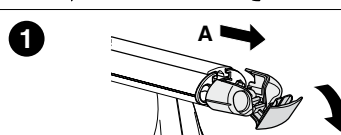

1

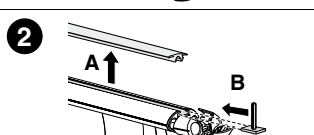

2

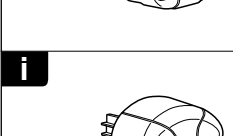

i

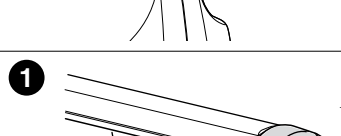

1

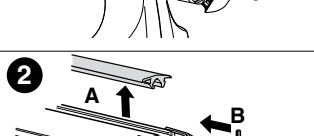

2

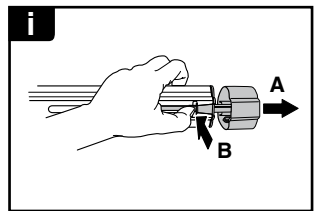
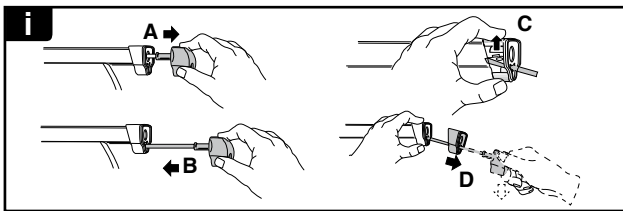
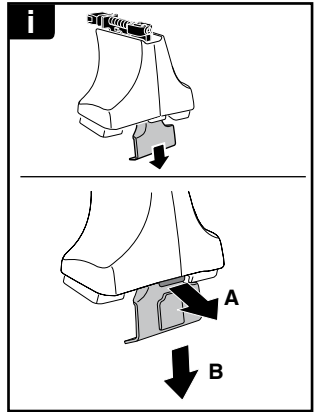
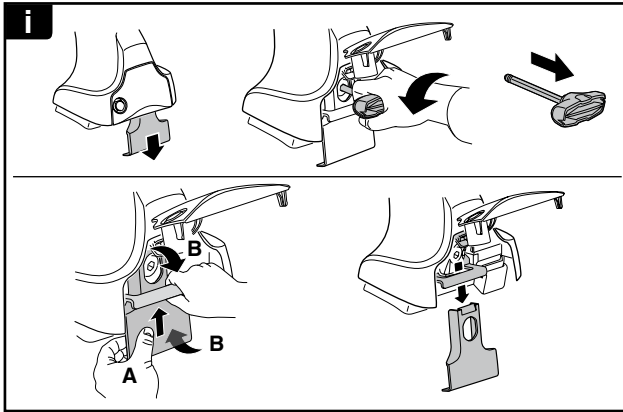

THULE
SWEDEN
**ONE
KEY
SYSTEM**



| | | |
|------|--|-------|
| | | (x4) |
| | | (x6) |
| | | (x8) |
| NA | | (x10) |
| EUR | | (x12) |
| ASIA | | (x12) |

