

Kit 1396

KIA Rio (Mk II), 4-dr Sedan, 05-10 / *06-11

KIA Rio (Mk II), 5-dr Hatchback, 05-10

KIA Rio Cinco, 5-dr Wagon, *06-11

*North America

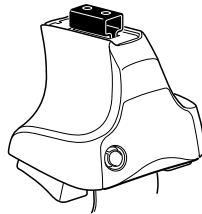

754 Rapid System
480R Rapid Traverse (North America)

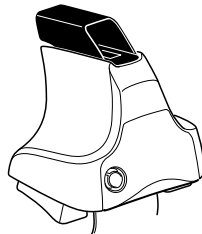
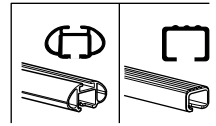

480 Traverse (North America)

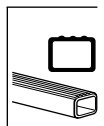

754 Rapid System
480R Rapid Traverse (North America)

480 Traverse (North America)

1

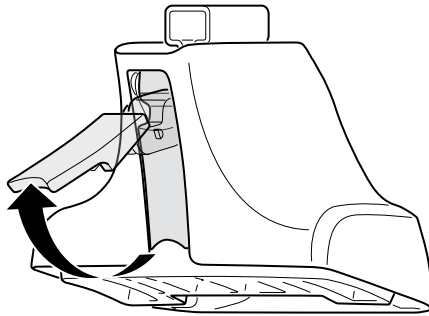

2



754 Rapid System
480R Rapid Traverse
(North America)

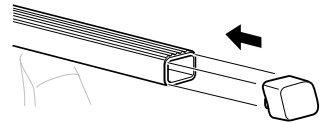
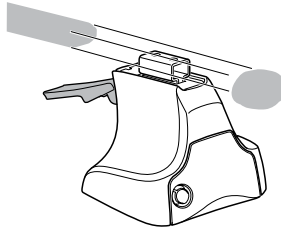

x4

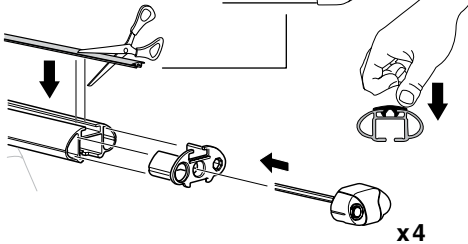
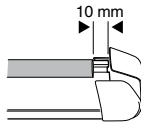
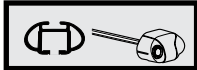

x4

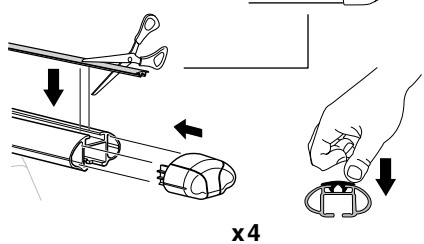
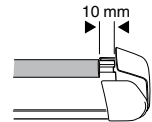

x4



480 Traverse
(North America)

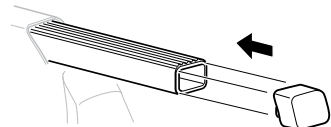
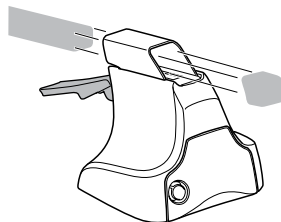

x4

3



754 Rapid System



X

KIA Rio (Mk II), 4-dr Sedan, 05-10 / *06-11	35
KIA Rio (Mk II), 5-dr Hatchback, 05-10	35
KIA Rio Cinco, 5-dr Wagon, *06-11	35

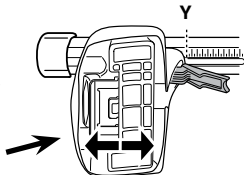

Y

KIA Rio (Mk II), 4-dr Sedan, 05-10 / *06-11	33,5
KIA Rio (Mk II), 5-dr Hatchback, 05-10	32,5
KIA Rio Cinco, 5-dr Wagon, *06-11	32,5

3



480R Rapid Traverse



480 Traverse

(North America)

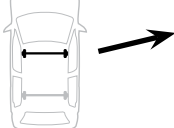
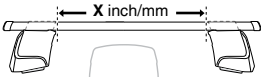

X inch

X mm

KIA Rio (Mk II), 4-dr Sedan, 05-10 / *06-11	39 3/8"	1001 mm
KIA Rio (Mk II), 5-dr Hatchback, 05-10	39 3/8"	1001 mm
KIA Rio Cinco, 5-dr Wagon, *06-11	39 3/8"	1001 mm

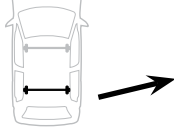

Y inch

Y mm

KIA Rio (Mk II), 4-dr Sedan, 05-10 / *06-11	38 7/8"	986 mm
KIA Rio (Mk II), 5-dr Hatchback, 05-10	38 3/8"	976 mm
KIA Rio Cinco, 5-dr Wagon, *06-11	38 3/8"	976 mm

4

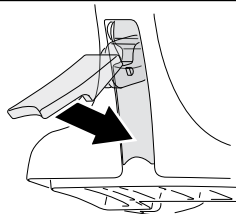

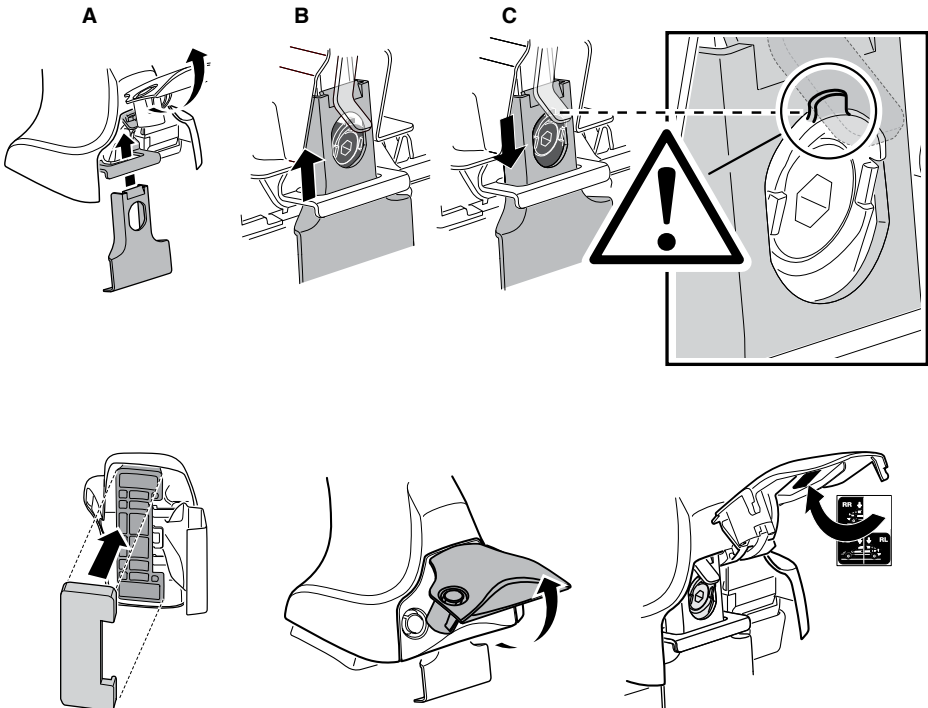
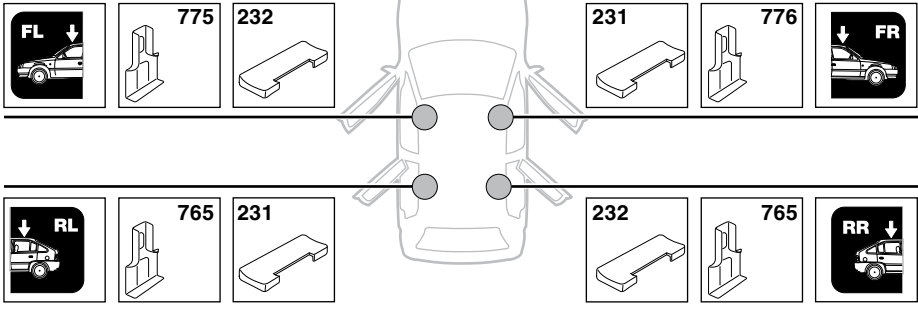
5**KIA Rio (Mk II), 4-dr Sedan, 05-10 / *06-11****KIA Rio (Mk II), 5-dr Hatchback, 05-10****KIA Rio Cinco, 5-dr Wagon, *06-11**

6

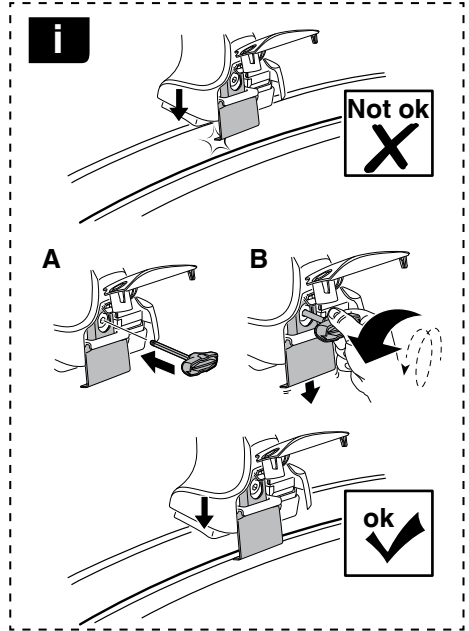
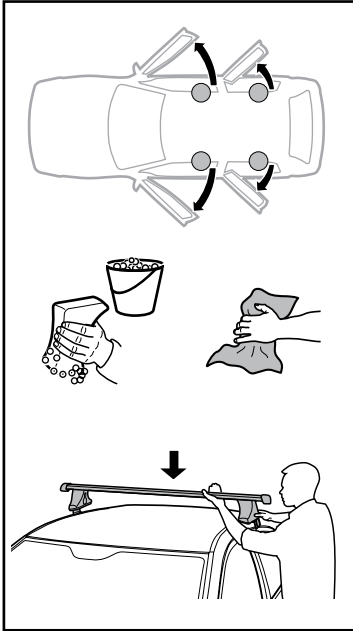

	X mm	Y mm	X inch	Y inch
KIA Rio (Mk II), 4-dr Sedan, 05-10 / *06-11	200 mm	650 mm	7 7/8"	25 5/8"
KIA Rio (Mk II), 5-dr Hatchback, 05-10	215 mm	670 mm	8 1/2"	26 3/8"
KIA Rio Cinco, 5-dr Wagon, *06-11	215 mm	670 mm	8 1/2"	26 3/8"

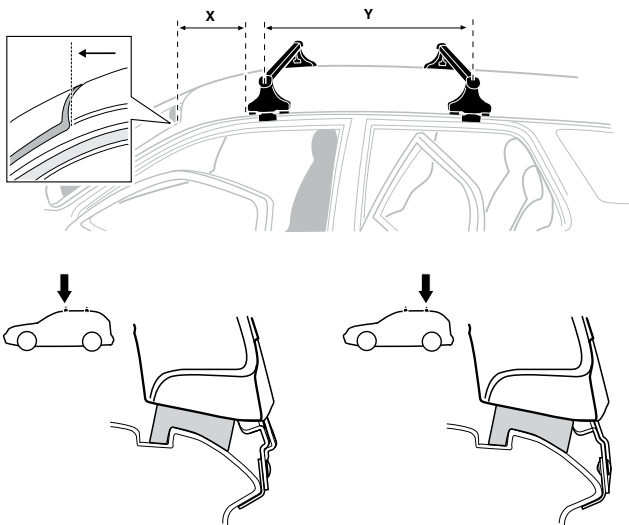

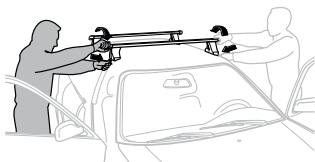
7

GB/US Tighten alternately
D Die Schrauben abwechselnd anziehen
F Serrer alternativement chaque côté
NL Afwisselend aan de linker- en de rechterkant aandraaien
I Alternare il serraggio delle viti
E Apertar alternativamente
PT Aperte alternadamente
S Dra åt växelvis
FIN Kierrä vuorotellen
EST Pinguldage vaheldumisi
LAT Pieļieciet pamišus
LIT Užsukinėkite pakaitomis
PL Śruby dokręcaj naprzemiennie
RU Затягивайте попеременно

CZ Pokręťta bagażnika dokręcaj dokręcaj naprzemiennie.
SK Dofahajte striedavo
SLO Privijajte izmenično.
HR Naizmjerno zategnite
HU Egymástól függetlenül szorítandó
GR Σφιγίγτες εναλλάξ
TR Dönüşümlü sıkın

中文 交替拧紧

한국어 번갈아 가며 조이십시오.

日本語 交互に締め付けてください。

ไทย ชันในแบบสลับ

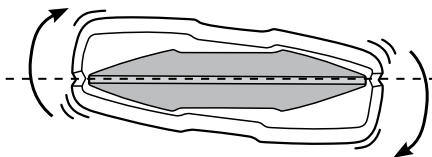
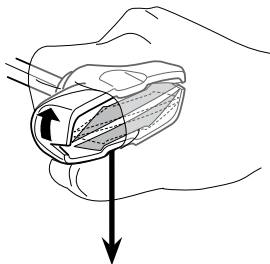
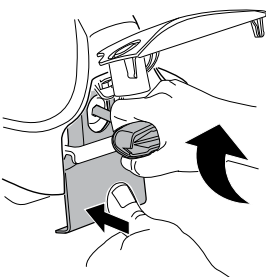
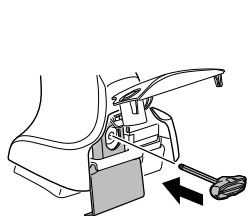

≈ 3 Nm

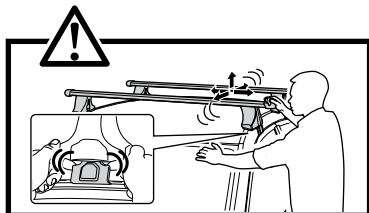
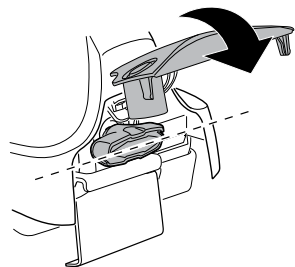
**8**

x1
17 mm

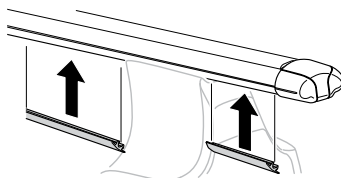
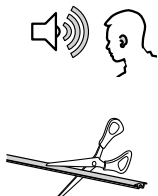

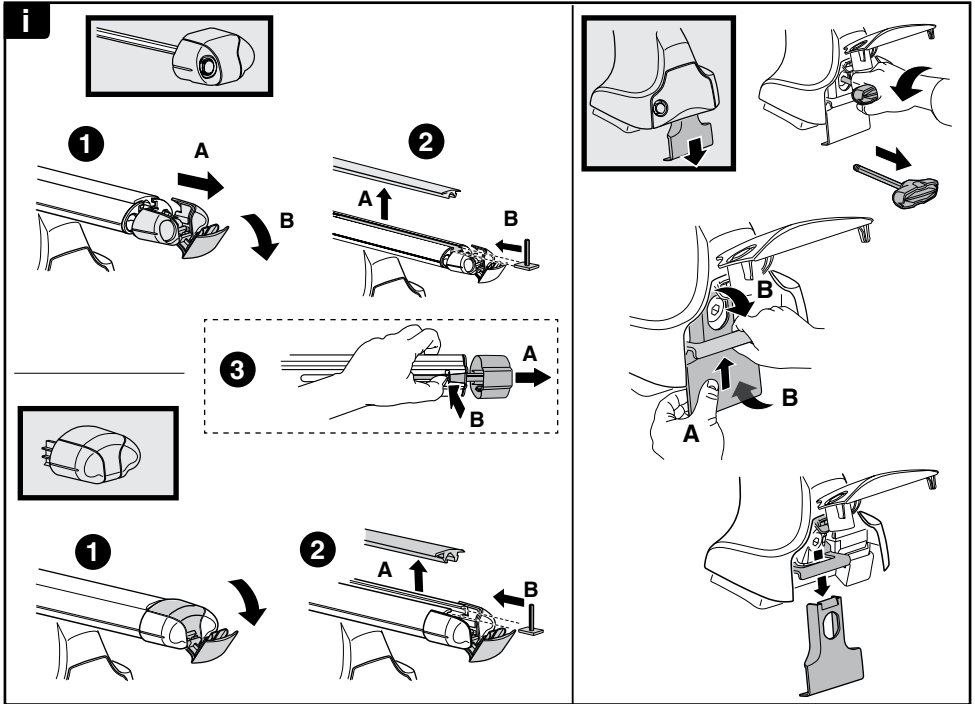

THULE
SWEDEN
**ONE
KEY
SYSTEM**

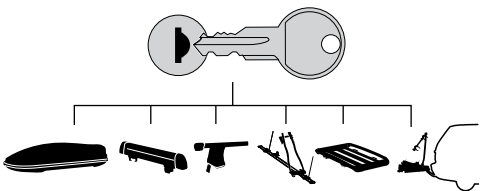

		544	(x4)
		596	(x6)
		588	(x8)
NA		510	(x10)
EUR		452	(x12)
ASIA			

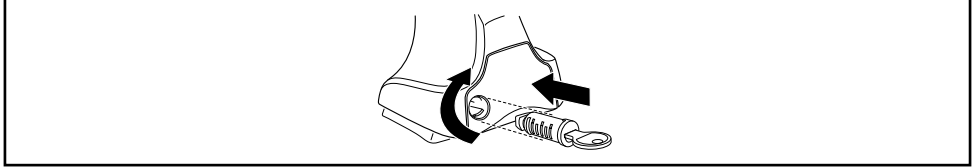

WW ▶ Thule Sweden AB, Box 69, 330 33 Hillerstorp, SWEDEN
NA ▶ Thule Inc., 42 Silvermine Road, Seymour, Connecticut 06483, USA

info@thule.com
customer.service@thule.com

www.thule.com