

Kit 1376

NISSAN Tiida, 5-dr Hatchback, 05-(JPN)

NISSAN Versa, 5-dr Hatchback, *07-10

*North America

480R
754

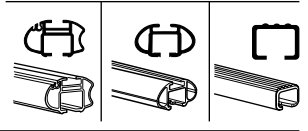
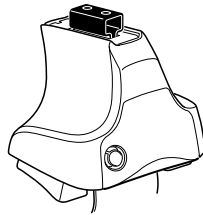

480

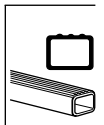
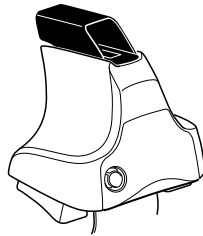

750

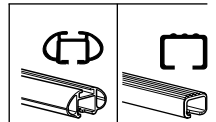
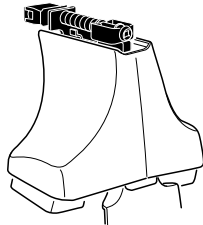

Kit



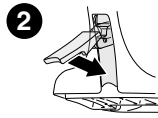
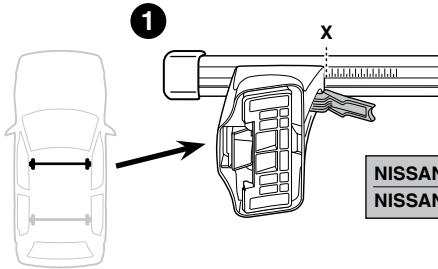

	X
NISSAN Tiida, 5-dr Hatchback, 05-(JPN)	36
NISSAN Versa, 5-dr Hatchback, *07-10	36

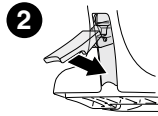
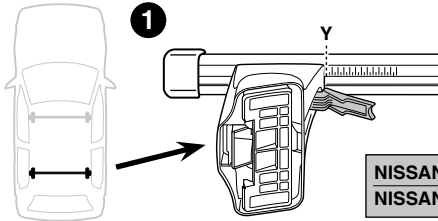

	Y
NISSAN Tiida, 5-dr Hatchback, 05-(JPN)	34,5
NISSAN Versa, 5-dr Hatchback, *07-10	34,5

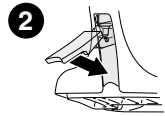
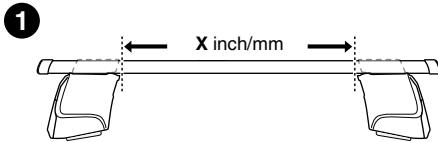
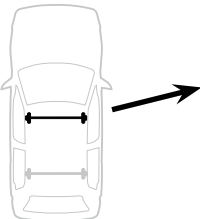

	X inch	X mm
NISSAN Tiida, 5-dr Hatchback, 05-(JPN)	39 3/4"	1011 mm
NISSAN Versa, 5-dr Hatchback, *07-10	39 3/4"	1011 mm

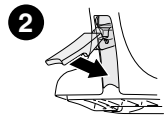
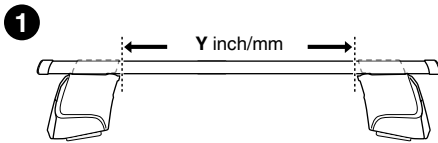
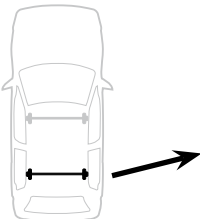

	Y inch	Y mm
NISSAN Tiida, 5-dr Hatchback, 05-(JPN)	39 1/4"	996 mm
NISSAN Versa, 5-dr Hatchback, *07-10	39 1/4"	996 mm

4

NISSAN Tiida, 5-dr Hatchback, 05-(JPN)
NISSAN Versa, 5-dr Hatchback, *07-10

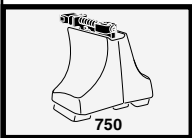
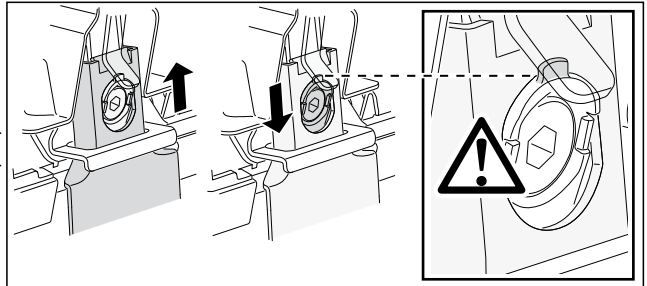
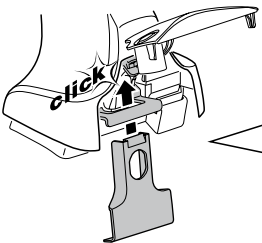
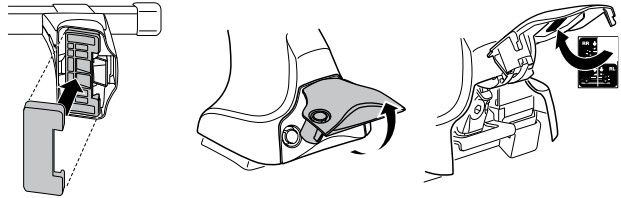
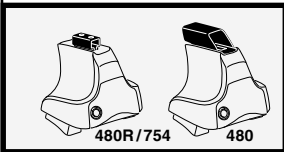
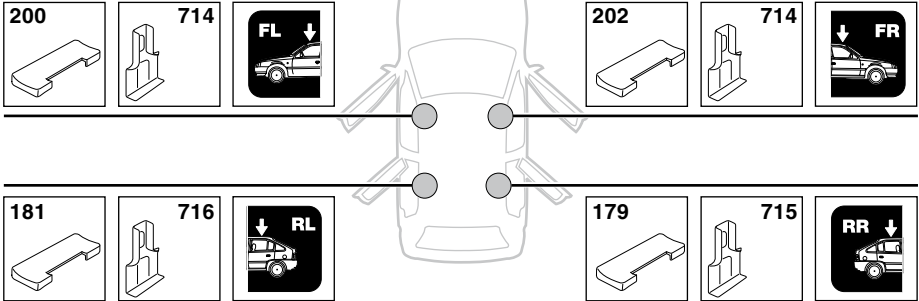

5

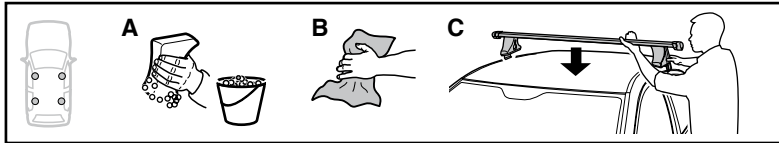

	X mm	Y mm	X inch	Y inch
NISSAN Tiida, 5-dr Hatchback, 05-(JPN)	440 mm	700 mm	17 ³ / ₈ "	27 ¹ / ₂ "
NISSAN Versa, 5-dr Hatchback, *07-10	440 mm	700 mm	17 ³ / ₈ "	27 ¹ / ₂ "

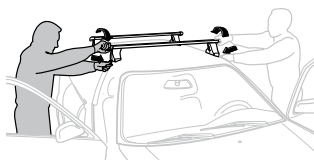
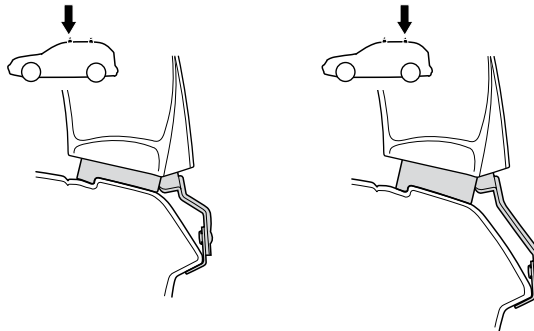
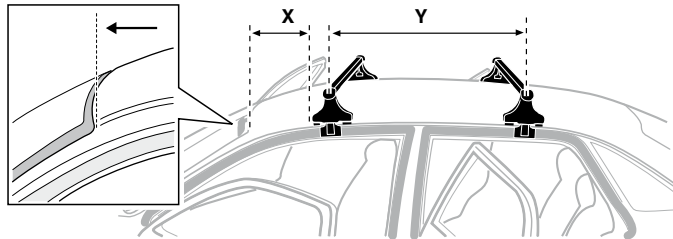

- | | | | |
|--------------|---|------------|---|
| GB/US | Tighten alternately | CZ | Pokręťte bagážníka dokřečaj dokřečaj naprzemiennie. |
| D | Die Schrauben abwechselnd anziehen | SK | Dofahujte striedavo |
| F | Serrer alternativement chaque côté | SLO | Privijajte izmenično. |
| NL | Afwisselend aan de linker- en de rechterkant aandraaien | HR | Naizmjenično zategnite |
| I | Alternare il serraggio delle viti | HU | Egymástól függetlenül szorítandó |
| E | Apretar alternativamente | GR | Σφιγγετε εναλλάξ |
| PT | Aperte alternadamente | TR | Dönüşümlü sıkın |
| S | Dra åt växelvis | 中文 | 交替拧紧 |
| FIN | Kierrä vuorotellen | 한국어 | 번갈아 가며 조이십시오. |
| EST | Pinguldage vaheldumisi | 日本語 | 交互に締め付けてください。 |
| LAT | Pievelciet pamišus | ไทย | ขันในแบบสลับ |
| LIT | Užsukinėkite pakaitomis | | |
| PL | Śruby dokřečaj naprzemiennie | | |
| RU | Затягивайте попеременно | | |

6



480R/754



480

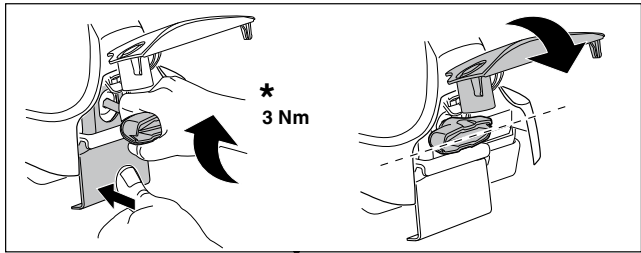

*
3 Nm



*



*
≈ 3 Nm

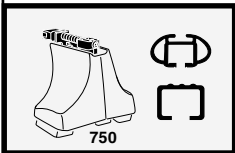

750

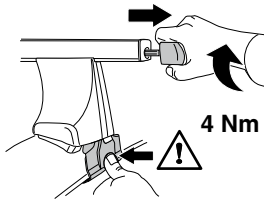

4 Nm

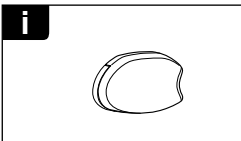
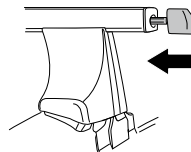

i

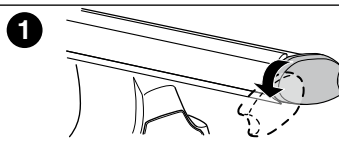

1

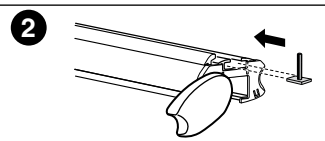

2

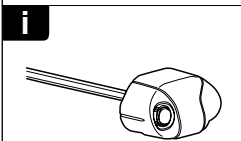

i

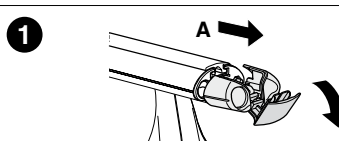

1

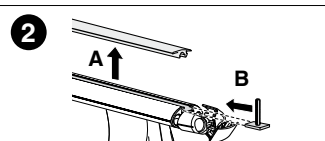

2

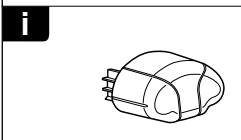

i



1

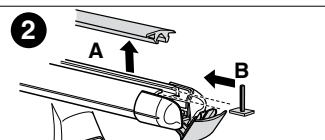

2

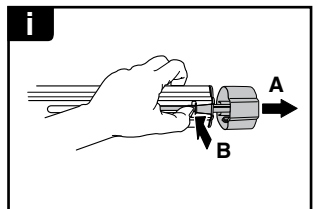
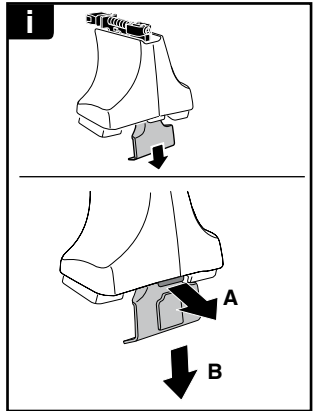

THULE
SWEDEN
**ONE
KEY
SYSTEM**



		(x4)
		(x6)
		(x8)
NA		(x10)
EUR		(x12)
ASIA		(x12)



ww ▶ Thule Sweden AB, Box 69, 330 33 Hillerstorp, SWEDEN
NA ▶ Thule Inc., 42 Silvermine Road, Seymour, Connecticut 06483, USA

info@thule.com
customer.service@thule.com

www.thule.com

503-1376-02