

Kit 1243

HONDA Civic, 4-dr Sedan, 01-05

HONDA Civic Ferio, 4-dr Sedan, 00-05

480R
754

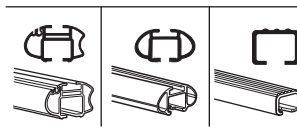
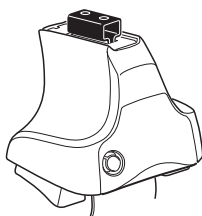

480

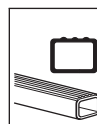
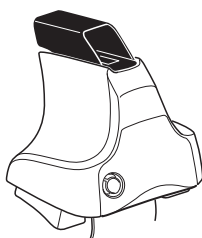

750

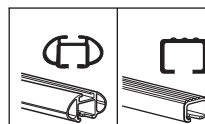
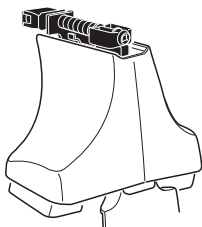

xx kg
 xx lbs

7 kg
 15,4 lbs

Max. 75kg
Max. 165 lbs

80 km/h 50 Mph
 130 km/h 80 Mph
 40 km/h 25 Mph
km/h Mph

THULE

Kit XXXX
 instructions

x1

x4

x4

x4

480R/754

x1

x4

x4

x4

480

x1

x4

x4

x4

750

x2 x2 x2 x4	x2	x2 x2 x4 x4	x2 x2	x2

307 x 4

06 x 4

x 1

Kit

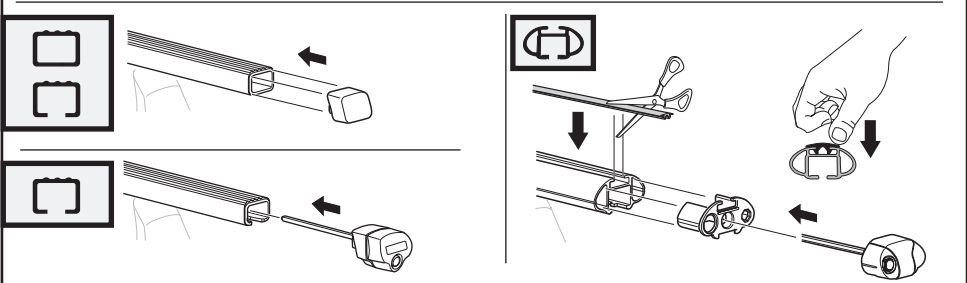
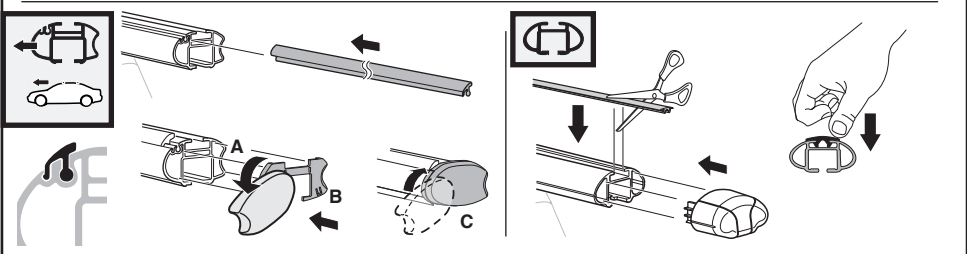
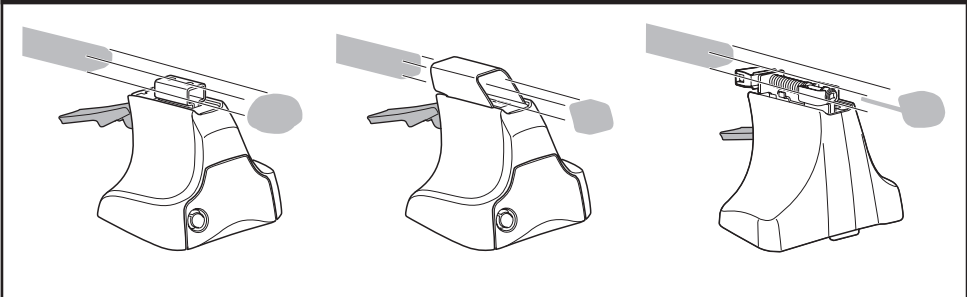
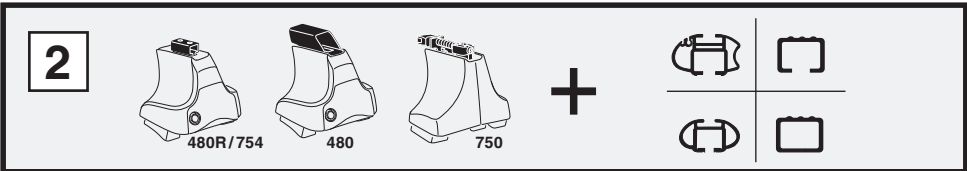
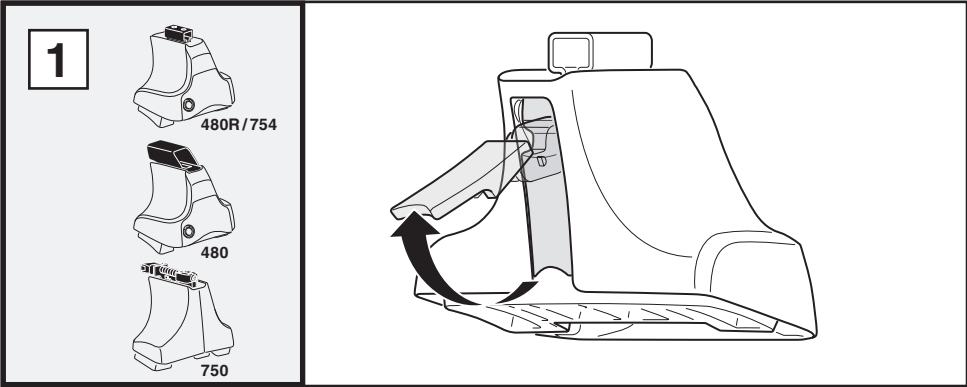

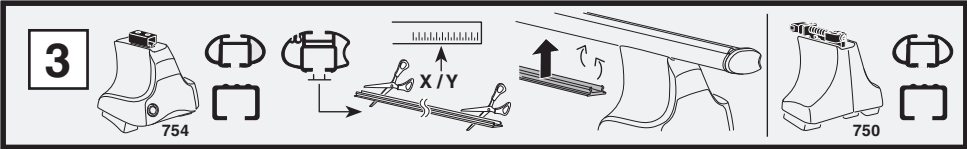

1

2

	X
HONDA Civic, 4-dr Sedan, 01-05	30,5
HONDA Civic Ferio, 4-dr Sedan, 00-05	30,5

1

2

	Y
HONDA Civic, 4-dr Sedan, 01-05	29,5
HONDA Civic Ferio, 4-dr Sedan, 00-05	29,5

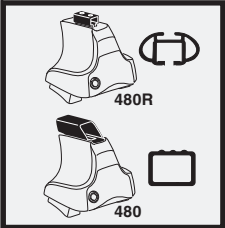

1

2

	X inch	X mm
HONDA Civic, 4-dr Sedan, 01-05	37 ⁵ / ₈ "	956 mm
HONDA Civic Ferio, 4-dr Sedan, 00-05	37 ⁵ / ₈ "	956 mm

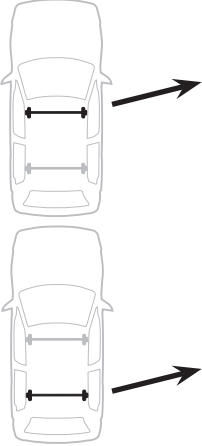

1

2

	Y inch	Y mm
HONDA Civic, 4-dr Sedan, 01-05	37 ¹ / ₄ "	946 mm
HONDA Civic Ferio, 4-dr Sedan, 00-05	37 ¹ / ₄ "	946 mm

4

HONDA Civic, 4-dr Sedan, 01-05
 HONDA Civic Ferio, 4-dr Sedan, 00-05

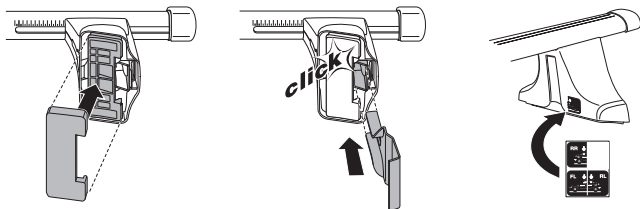
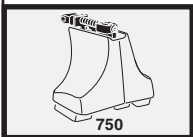
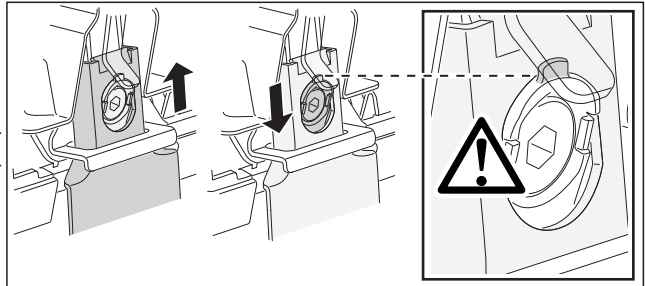
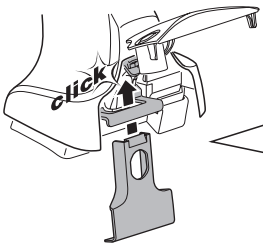
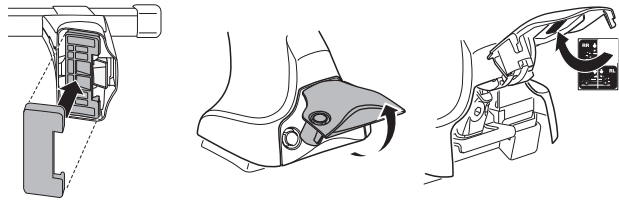
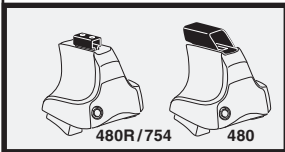
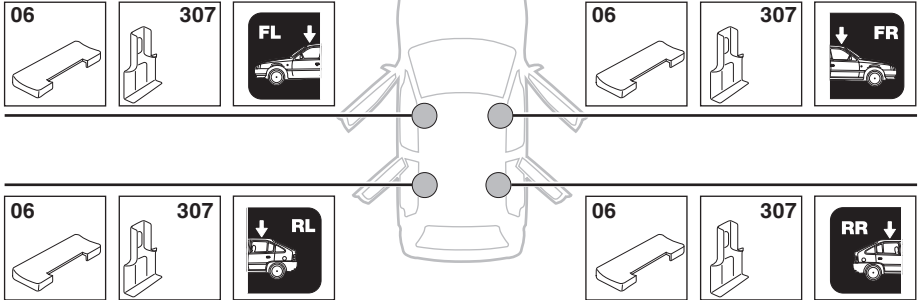

5

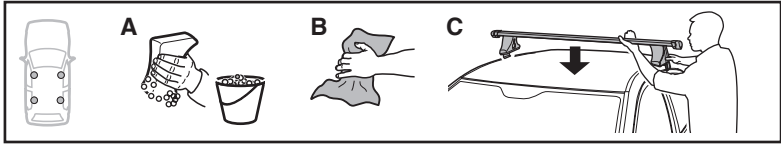

	X mm	Y mm	X inch	Y inch
HONDA Civic, 4-dr Sedan, 01-05	250 mm	700 mm	9 7/8"	27 1/2"
HONDA Civic Ferio, 4-dr Sedan, 00-05	250 mm	700 mm	9 7/8"	27 1/2"

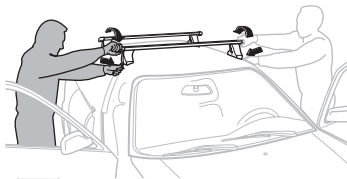
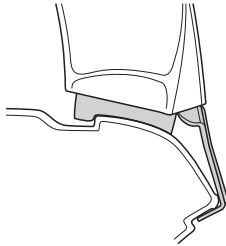
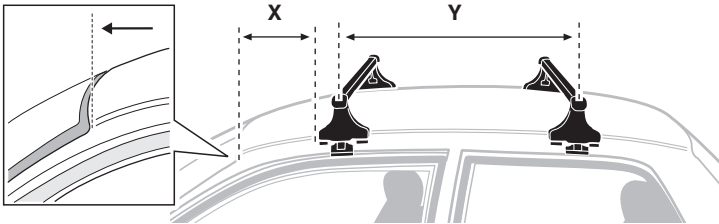

GB/US Tighten alternately

D Die Schrauben abwechselnd anziehen

F Serrer alternativement chaque côté

NL Afwisselend aan de linker- en de rechterkant aandraaien

I Alternare il serraggio delle viti

E Serrare alternativamente

PT Aperte alternadamente

S Dra åt växelvis

FIN Kierrä vuorotellen

EST Pinguldage vaheldumisi

LAT Pielieciet pamišus

LIT Užsukinėkite pakaitomis

PL Śruby dokręcaj naprzemiennie

RU Затягивайте попеременно

CZ Pokręťta bagażníka dokręcaj dokręcaj naprzemiennie.

SK Doťahujte striedavo

SLO Privijajte izmenično.

HR Naizmjenično zategnite

HU Egymástól függetlenül szorítandó

GR Σφίγγετε εναλλάξ

TR Dönüşümlü sıkın

中文 交替拧紧

한국어 번갈아 가며 조이십시오.

日本語 交互に締め付けてください。

ไทย ชั้้นโน้บแบบสลับ

6



480R/754



480

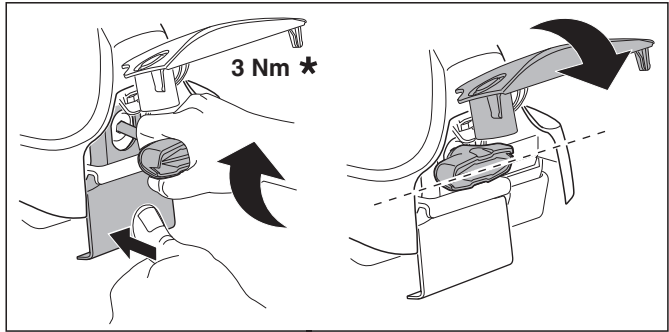
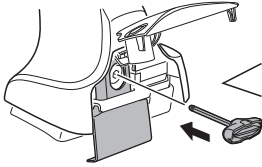

3 Nm *

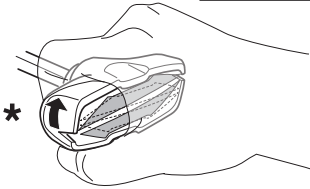

*

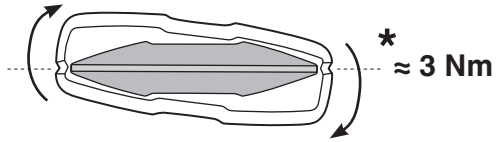

* ≈ 3 Nm



750

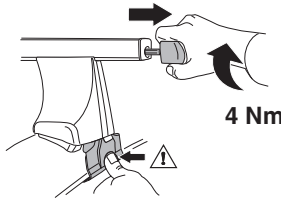

4 Nm

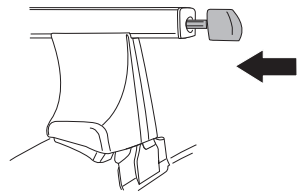

i



1



2

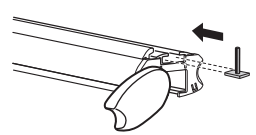

i

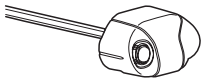

1

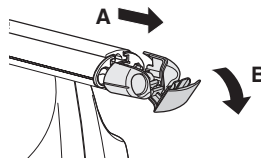

2

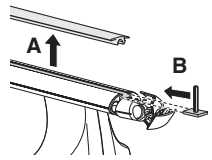

i



1

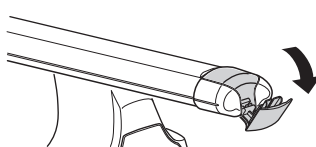

2

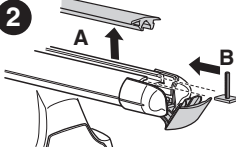

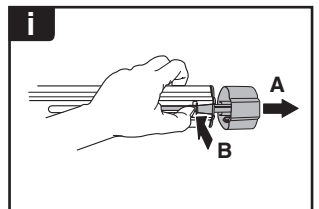
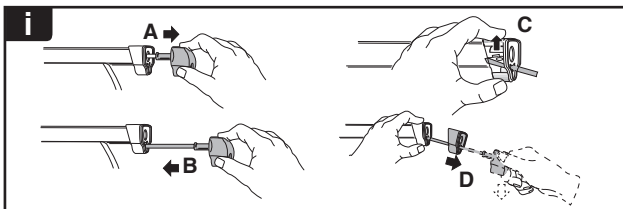
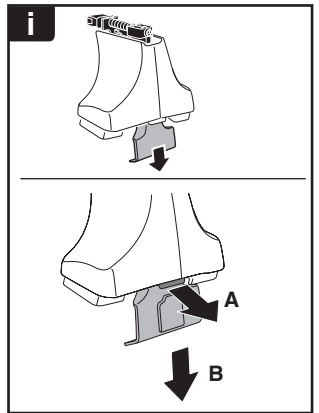
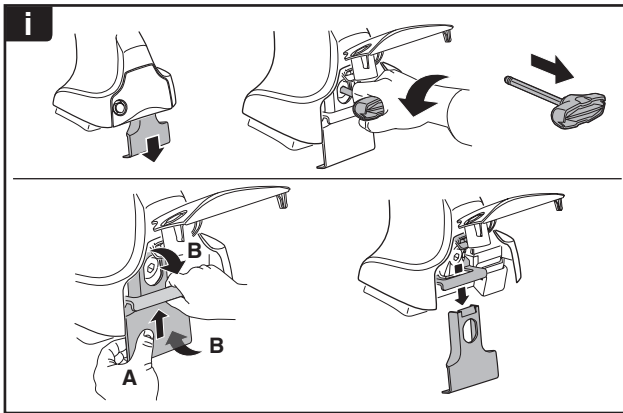
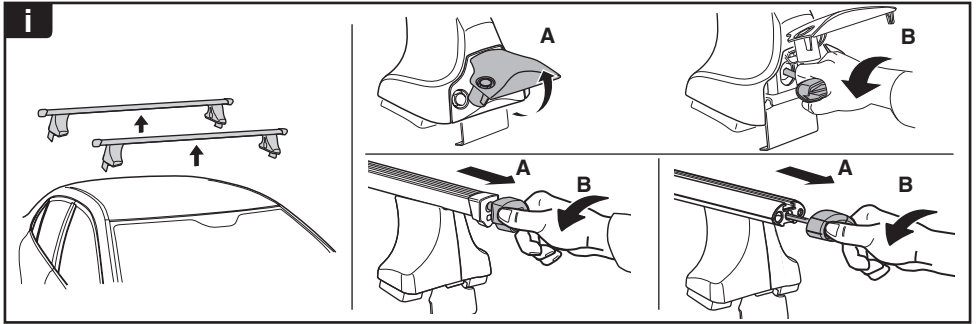

THULE
SWEDEN
**ONE
KEY
SYSTEM**

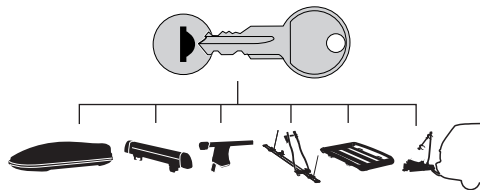

- 544 (x4)
- 596 (x6)
- 588 (x8)
- NA 510 (x10)
- EUR 452 (x12)
- ASIA

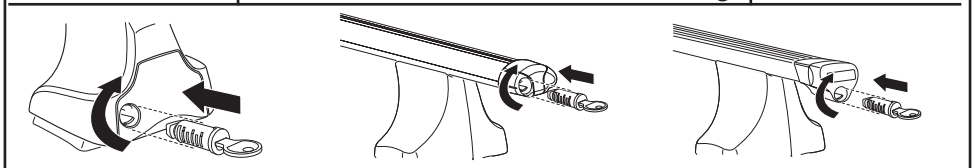

WW ▶ Thule Sweden AB, Box 69, 330 33 Hillerstorp, SWEDEN
NA ▶ Thule Inc., 42 Silvermine Road, Seymour, Connecticut 06483, USA

info@thule.com
customer.service@thule.com

www.thule.com