

Kit 1203

CHRYSLER PT Cruiser, 5-dr Estate, 00-09
CHRYSLER PT Cruiser, 5-dr Wagon, *01-10
DAEWOO Musso, 5-dr SUV, 93-05
SSANGYONG Musso, 5-dr SUV, 93-05

*North America

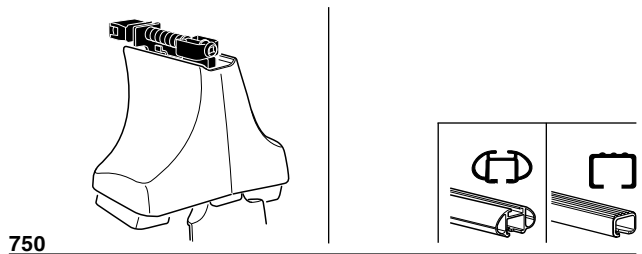
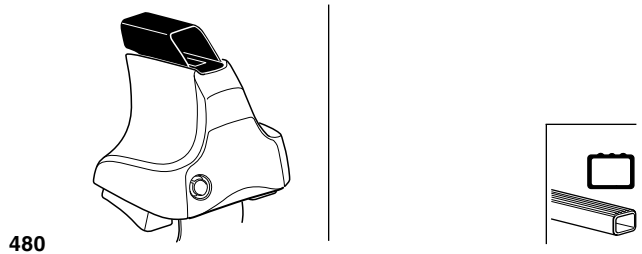
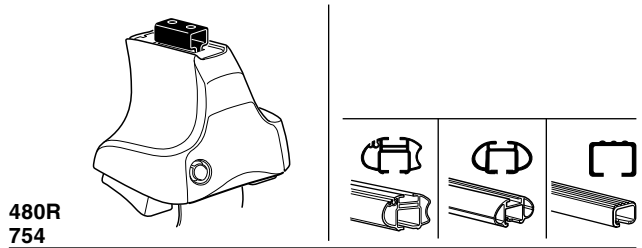

CHRYSLER PT Cruiser, 5-dr Estate, 00-09
 CHRYSLER PT Cruiser, 5-dr Wagon, '01-10

Max.
75 kg/165 lbs

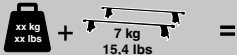

DAEWOO Musso, 5-dr SUV, 93-05
 SSANGYONG Musso, 5-dr SUV, 93-05

Max.
50 kg/110 lbs

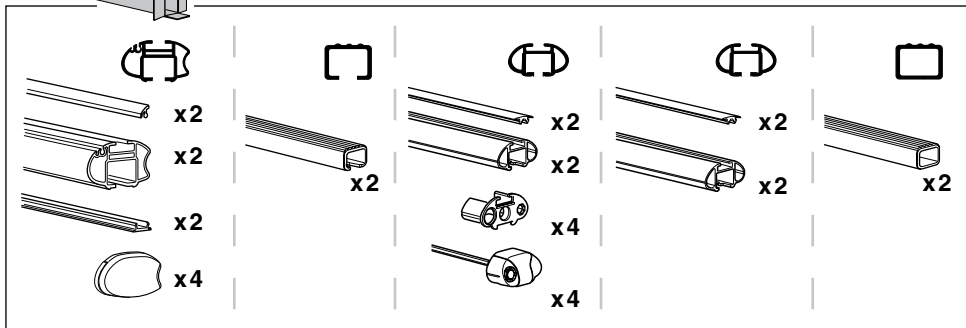
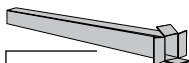
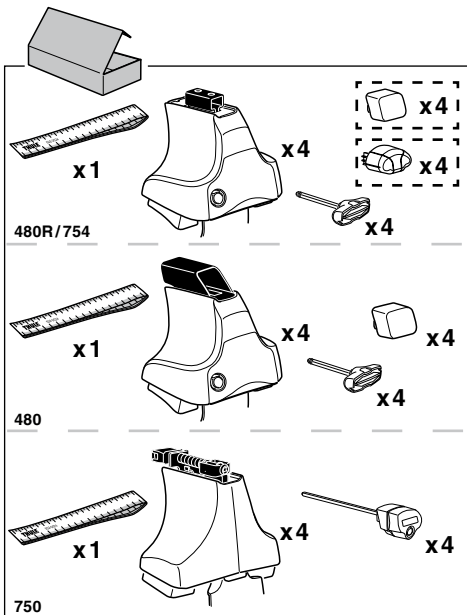
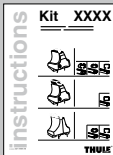
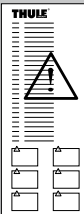

363 x 4

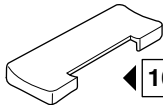

16 x 4



x 1

Kit

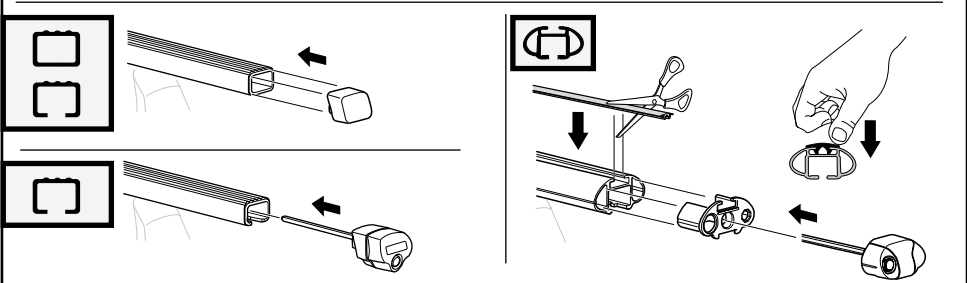
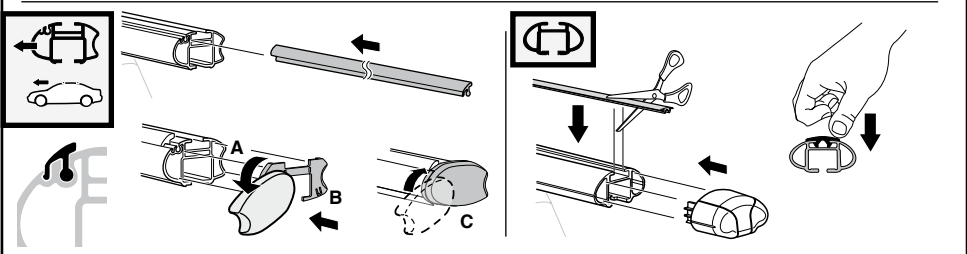
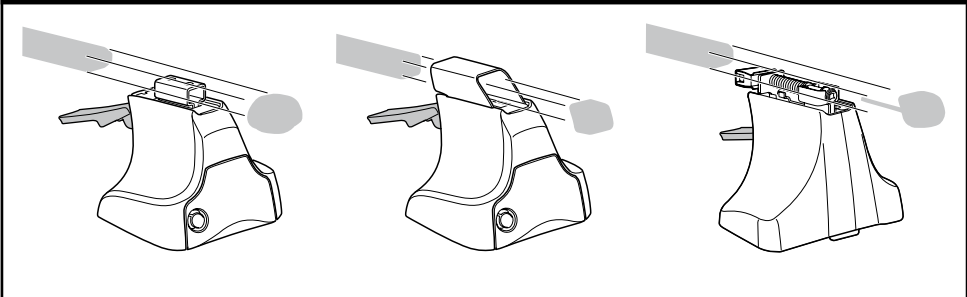

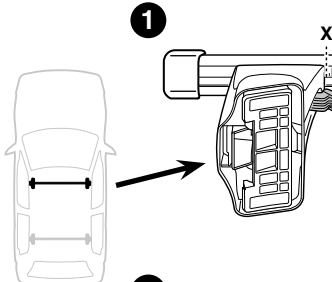
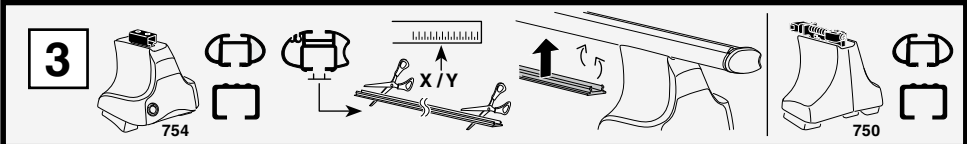

	X
CHRYSLER PT Cruiser, 5-dr Estate, 00-09	32,5
CHRYSLER PT Cruiser, 5-dr Wagon, *01-10	32,5
DAEWOO Musso, 5-dr SUV, 93-05	39
SSANGYONG Musso, 5-dr SUV, 93-05	39

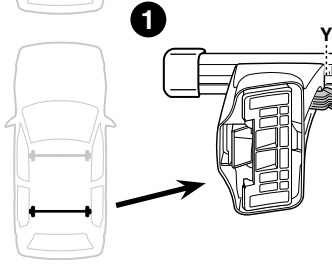
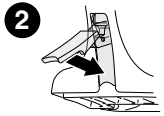

	Y
CHRYSLER PT Cruiser, 5-dr Estate, 00-09	28
CHRYSLER PT Cruiser, 5-dr Wagon, *01-10	28
DAEWOO Musso, 5-dr SUV, 93-05	38,5
SSANGYONG Musso, 5-dr SUV, 93-05	38,5

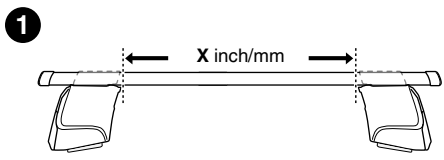
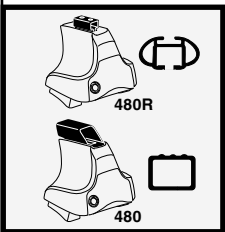

	X inch	X mm
CHRYSLER PT Cruiser, 5-dr Estate, 00-09	38 ³/₈ "	976 mm
CHRYSLER PT Cruiser, 5-dr Wagon, *01-10	38 ³/₈ "	976 mm
DAEWOO Musso, 5-dr SUV, 93-05	41 "	1041 mm
SSANGYONG Musso, 5-dr SUV, 93-05	41 "	1041 mm

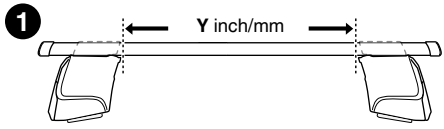
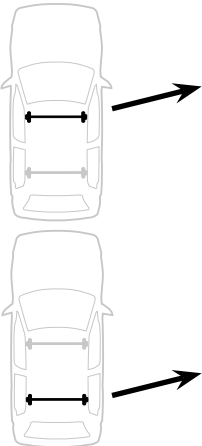
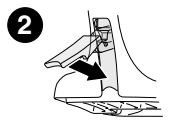

	Y inch	Y mm
CHRYSLER PT Cruiser, 5-dr Estate, 00-09	36 ⁵/₈ "	931 mm
CHRYSLER PT Cruiser, 5-dr Wagon, *01-10	36 ⁵/₈ "	931 mm
DAEWOO Musso, 5-dr SUV, 93-05	40 ³/₄ "	1036 mm
SSANGYONG Musso, 5-dr SUV, 93-05	40 ³/₄ "	1036 mm

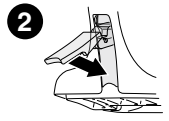

4

CHRYSLER PT Cruiser, 5-dr Estate, 00-09
 CHRYSLER PT Cruiser, 5-dr Wagon, *01-10
 DAEWOO Musso, 5-dr SUV, 93-05
 SSANGYONG Musso, 5-dr SUV, 93-05

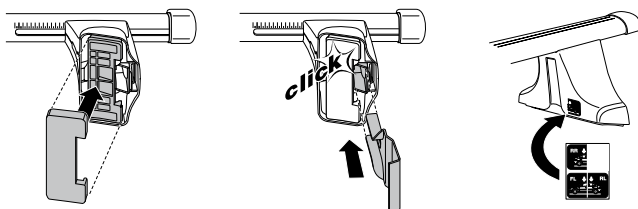
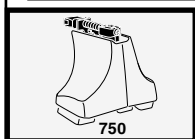
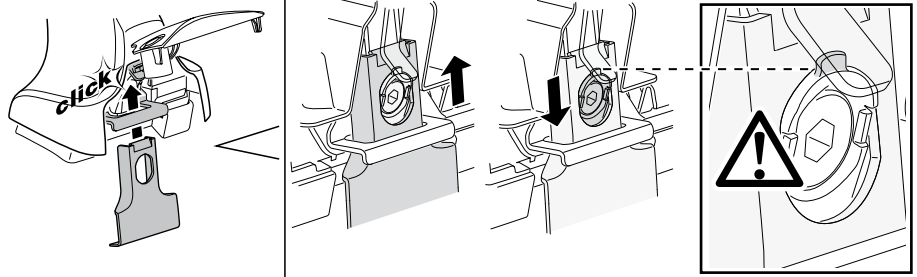
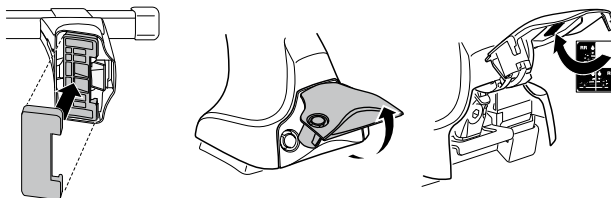
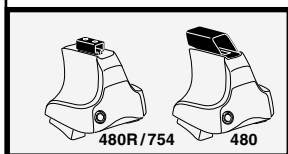
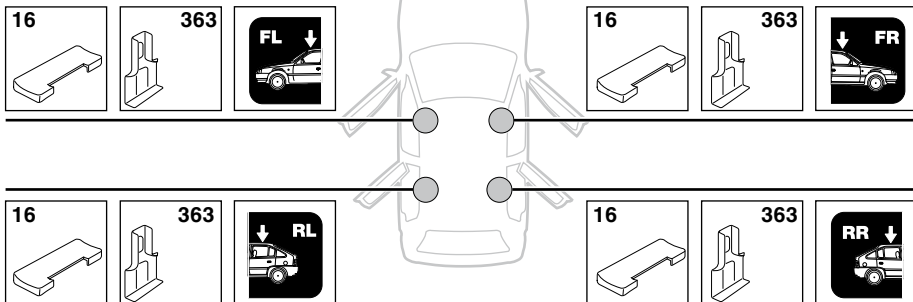

5

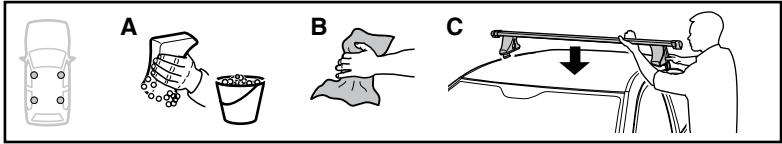

	X mm	Y mm	X inch	Y inch
CHRYSLER PT Cruiser , 5-dr Estate, 00-09	290 mm	700 mm	11 3/8"	27 1/2"
CHRYSLER PT Cruiser , 5-dr Wagon, *01-10	290 mm	700 mm	11 3/8"	27 1/2"
DAEWOO Musso , 5-dr SUV, 93-05	300 mm	700 mm	11 3/4"	27 1/2"
SSANGYONG Musso , 5-dr SUV, 93-05	300 mm	700 mm	11 3/4"	27 1/2"

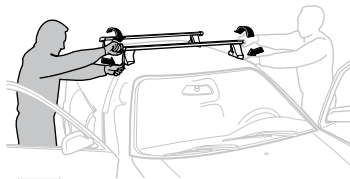
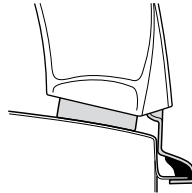
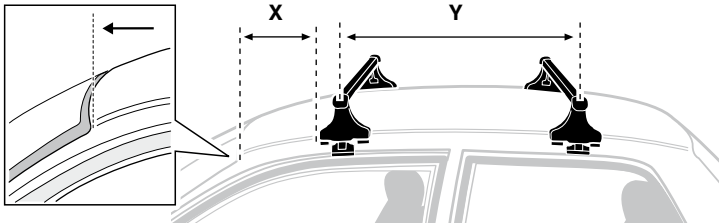

GB/US Tighten alternately

D Die Schrauben abwechselnd anziehen

F Serrer alternativement chaque côté

NL Afwisselend aan de linker- en de rechterkant aandraaien

I Alternare il serraggio delle viti

E Serrare alternativamente

PT Aperte alternadamente

S Dra åt växelvis

FIN Kierrä vuorotellen

EST Pinguldage vaheldumisi

LAT Pielvelciēt pamīšus

LIT Užsukinėkite pakaitomis

PL Śruby dokręcaj naprzemiennie

RU Затягивайте попеременно

CZ Pokręťta bagażníka dokręcaj dokręcaj naprzemiennie.

SK Doťahujte striedavo

SLO Privijajte izmenično.

HR Naizmjenično zategnite

HU Egymástól függetlenül szorítandó

GR Σφίγγετε εναλλάξ

TR Dönüşümlü sıkın

中文 交替拧紧

한국어 번갈아 가며 조이십시오.

日本語 交互に締め付けてください。

ไทย ชั้โน้แบบสลับ

6

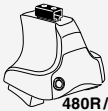

480R/754



480

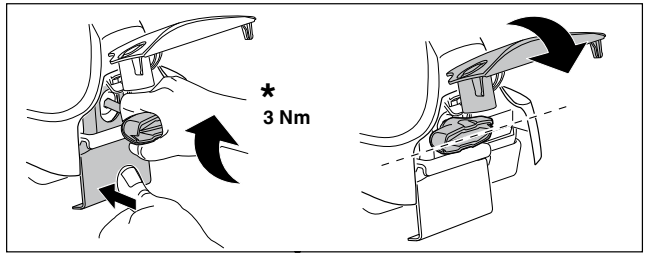
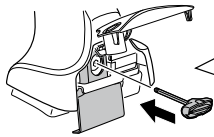

*
3 Nm

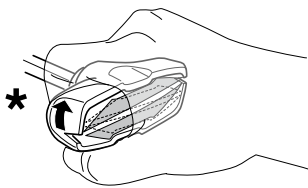

*

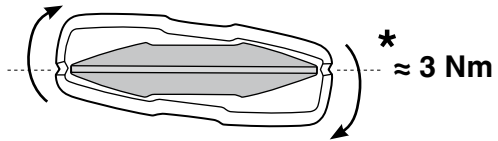

*
≈ 3 Nm

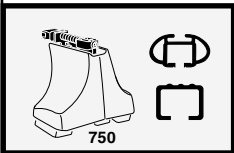
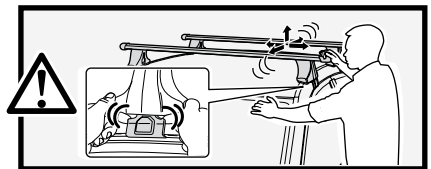

750

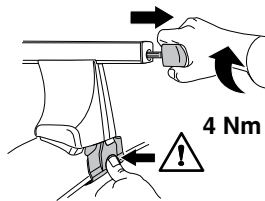

4 Nm

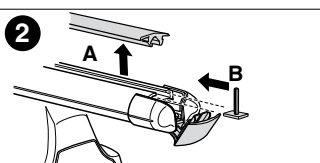
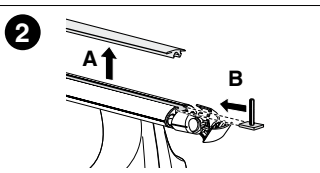
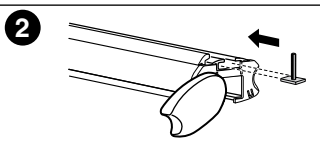
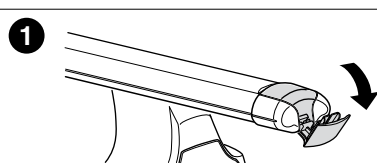
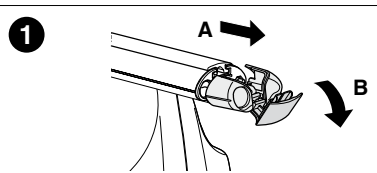
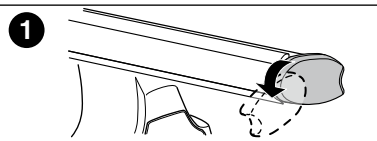
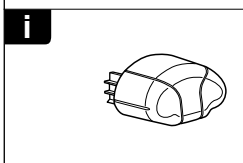
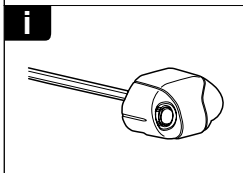
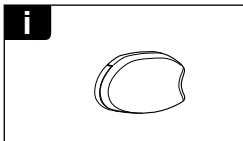
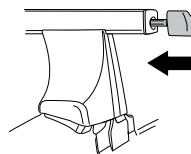

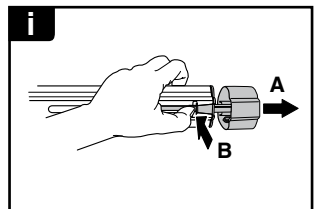
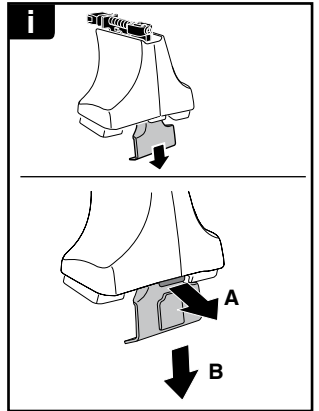
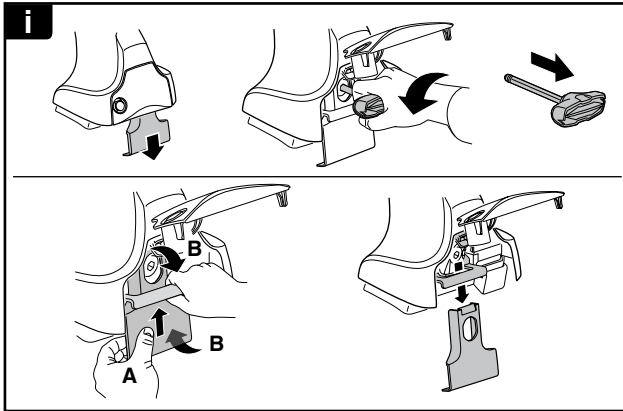
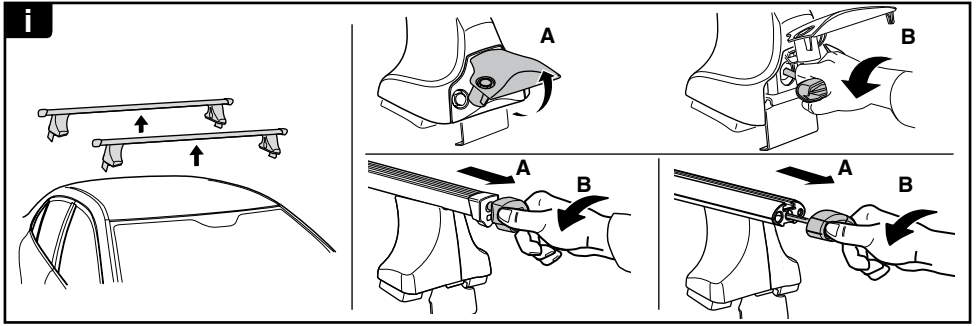

THULE
SWEDEN
**ONE
KEY
SYSTEM**

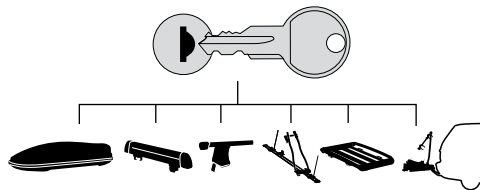

		544	(x4)
		596	(x6)
		588	(x8)
NA		510	(x10)
EUR		452	(x12)
ASIA			

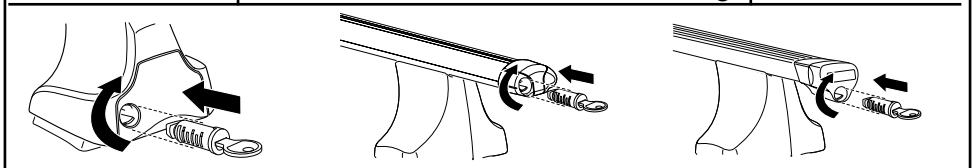

WW ▶ Thule Sweden AB, Box 69, 330 33 Hillerstorp, SWEDEN
NA ▶ Thule Inc., 42 Silvermine Road, Seymour, Connecticut 06483, USA

info@thule.com
customer.service@thule.com

www.thule.com

503-1203-02