

# Kit 1043

- CHRYSLER Voyager**, 5-dr MPV, 96-00
  - CHRYSLER Grand Voyager**, 5-dr MPV, 96-00
  - CHRYSLER Town & Country**, 5-dr MPV, 96-00
  - CHRYSLER Town & Country**, 5-dr Minivan, \*08-
  - DODGE Grand Caravan**, 5-dr Minivan, \*08-
  - VOLKSWAGEN Routan**, 5-dr Minivan, \*09-
- \*North America

This Kit is only for vehicles with Dual Sliding Doors.

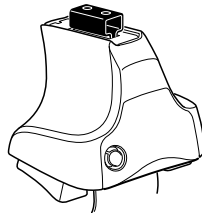

**754** Rapid System  
**480R** Rapid Traverse (North America)

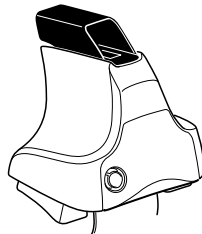
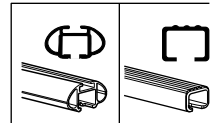

**480** Traverse (North America)

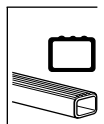

CHRYSLER Voyager, 5-dr MPV, 96-00  
 CHRYSLER Grand Voyager, 5-dr MPV, 96-00  
 CHRYSLER Town & Country, 5-dr MPV, 96-00

**Max.**  
**50kg/110 lbs**



CHRYSLER Town & Country, 5-dr Minivan, \*08-  
 DODGE Grand Caravan, 5-dr Minivan, \*08-  
 VOLKSWAGEN Routan, 5-dr Minivan, \*09-

**Max.**  
**40 kg/88 lbs**

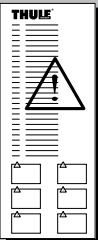
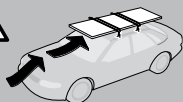

+

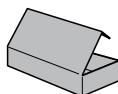

x1

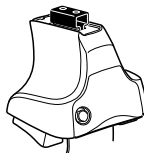

**754** Rapid System x4



**480R** Rapid Traverse (North America) x4



x4

**754** Rapid System

**480R** Rapid Traverse (North America)



x1

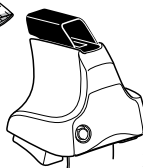

x4



x4



x4

**480** Traverse (North America)

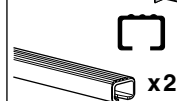
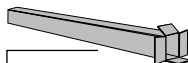

x2

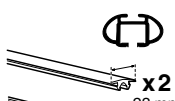

x2  
23 mm

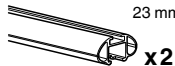

x2  
23 mm



x2  
23 mm

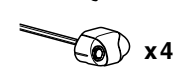

x2  
23 mm

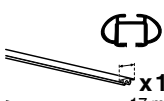

x1  
17 mm

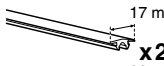

x2  
23 mm

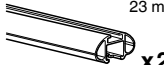

x2  
23 mm

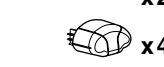

x4  
23 mm

(North America)



x2  
23 mm



x2  
23 mm

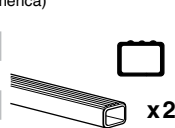

x2



**106** x4

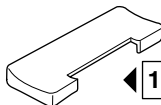

**16** x4



x1

1

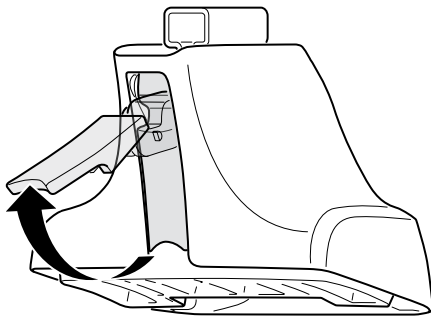

2



754 Rapid System  
480R Rapid Traverse  
(North America)

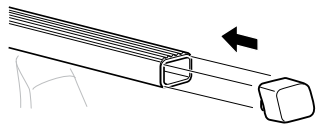
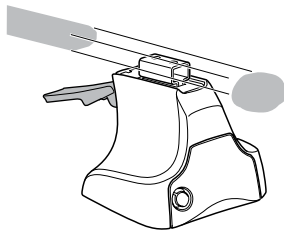

x4

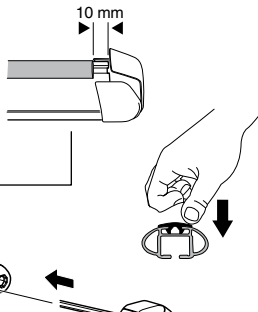
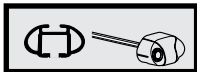

x4

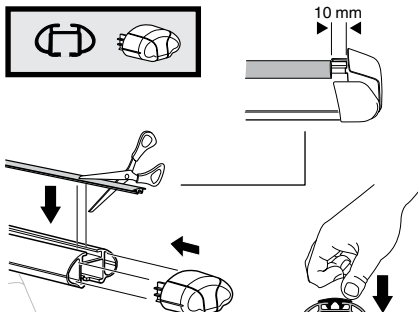
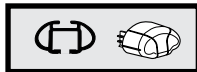

x4



480 Traverse  
(North America)

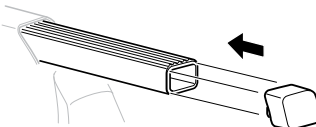
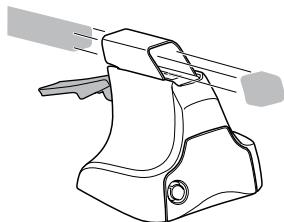

x4

**3**



**754** Rapid System

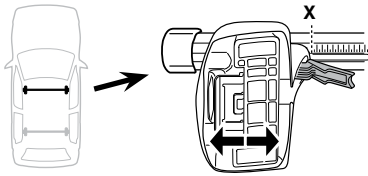

	X
<b>CHRYSLER Voyager</b> , 5-dr MPV, 96-00	37
<b>CHRYSLER Grand Voyager</b> , 5-dr MPV, 96-00	37
<b>CHRYSLER Town &amp; Country</b> , 5-dr MPV, 96-00	37
<b>CHRYSLER Town &amp; Country</b> , 5-dr Minivan, *08-	50
<b>DODGE Grand Caravan</b> , 5-dr Minivan, *08-	50
<b>VOLKSWAGEN Routan</b> , 5-dr Minivan, *09-	50

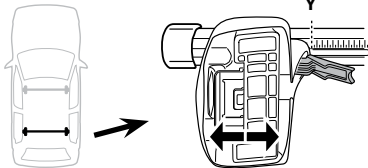

	Y
<b>CHRYSLER Voyager</b> , 5-dr MPV, 96-00	37
<b>CHRYSLER Grand Voyager</b> , 5-dr MPV, 96-00	37
<b>CHRYSLER Town &amp; Country</b> , 5-dr MPV, 96-00	37
<b>CHRYSLER Town &amp; Country</b> , 5-dr Minivan, *08-	49
<b>DODGE Grand Caravan</b> , 5-dr Minivan, *08-	49
<b>VOLKSWAGEN Routan</b> , 5-dr Minivan, *09-	49

**3**

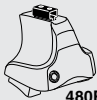

**480R** Rapid Traverse



**480** Traverse



**(North America)**

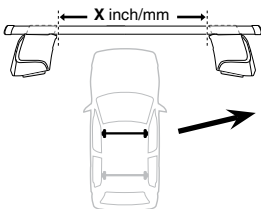

	X inch	X mm
<b>CHRYSLER Voyager</b> , 5-dr MPV, 96-00	40 1/4"	1021 mm
<b>CHRYSLER Grand Voyager</b> , 5-dr MPV, 96-00	40 1/4"	1021 mm
<b>CHRYSLER Town &amp; Country</b> , 5-dr MPV, 96-00	40 1/4"	1021 mm
<b>CHRYSLER Town &amp; Country</b> , 5-dr Minivan, *08-	45 3/8"	1151 mm
<b>DODGE Grand Caravan</b> , 5-dr Minivan, *08-	45 3/8"	1151 mm
<b>VOLKSWAGEN Routan</b> , 5-dr Minivan, *09-	45 3/8"	1151 mm

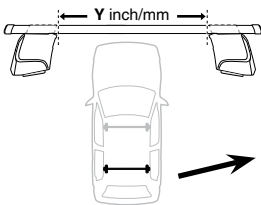

	Y inch	Y mm
<b>CHRYSLER Voyager</b> , 5-dr MPV, 96-00	40 1/4"	1021 mm
<b>CHRYSLER Grand Voyager</b> , 5-dr MPV, 96-00	40 1/4"	1021 mm
<b>CHRYSLER Town &amp; Country</b> , 5-dr MPV, 96-00	40 1/4"	1021 mm
<b>CHRYSLER Town &amp; Country</b> , 5-dr Minivan, *08-	44 7/8"	1140 mm
<b>DODGE Grand Caravan</b> , 5-dr Minivan, *08-	44 7/8"	1140 mm
<b>VOLKSWAGEN Routan</b> , 5-dr Minivan, *09-	44 7/8"	1140 mm

**4**

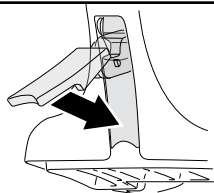

# 5

**CHRYSLER Voyager**, 5-dr MPV, 96-00  
**CHRYSLER Grand Voyager**, 5-dr MPV, 96-00  
**CHRYSLER Town & Country**, 5-dr MPV, 96-00  
**CHRYSLER Town & Country**, 5-dr Minivan, \*08-  
**DODGE Grand Caravan**, 5-dr Minivan, \*08-  
**VOLKSWAGEN Routan**, 5-dr Minivan, \*09-

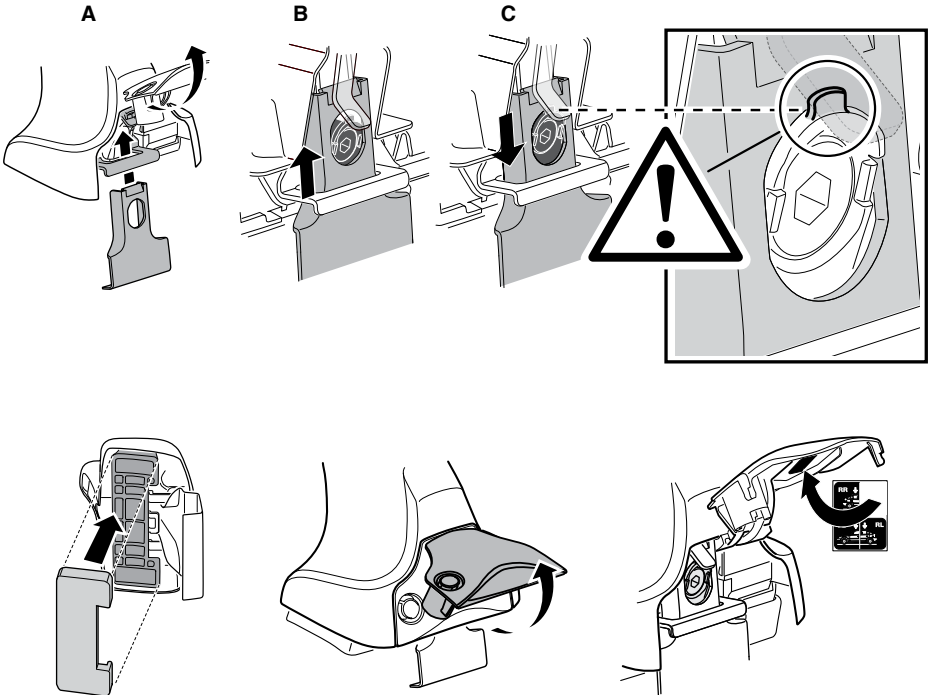
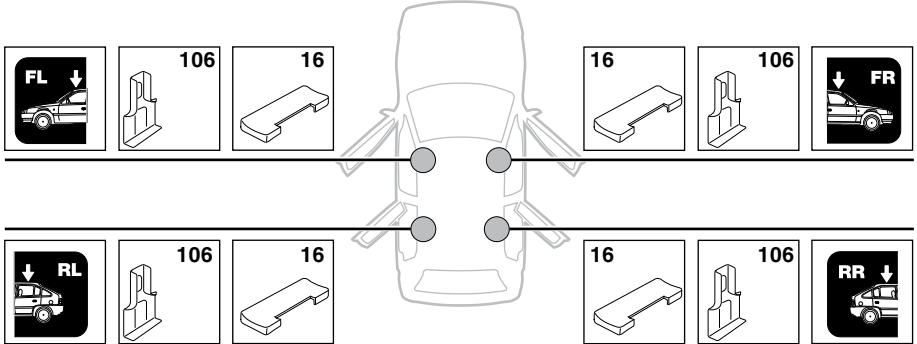

6

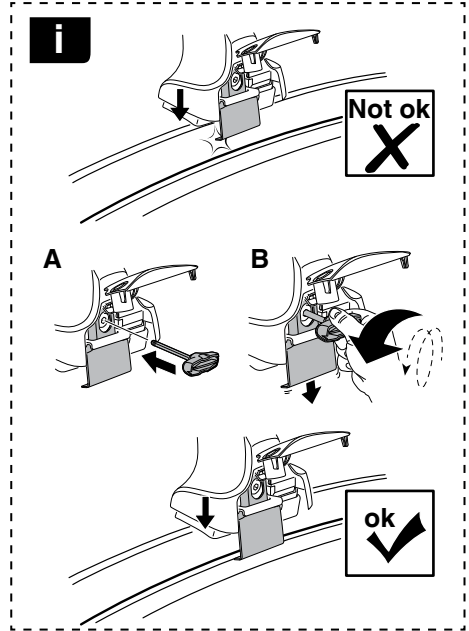
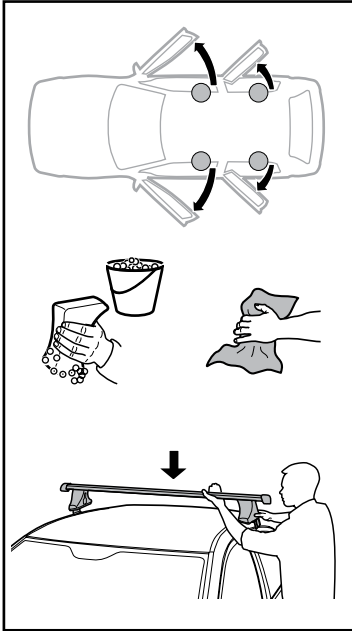

	X mm	Y mm	X inch	Y inch
<b>CHRYSLER Voyager</b> , 5-dr MPV, 96-00	630 mm	700 mm	24 3/4"	27 1/2"
<b>CHRYSLER Grand Voyager</b> , 5-dr MPV, 96-00	630 mm	700 mm	24 3/4"	27 1/2"
<b>CHRYSLER Town &amp; Country</b> , 5-dr MPV, 96-00	630 mm	700 mm	24 3/4"	27 1/2"
<b>CHRYSLER Town &amp; Country</b> , 5-dr Minivan, *08-	700 mm	700 mm	27 1/2"	27 1/2"
<b>DODGE Grand Caravan</b> , 5-dr Minivan, *08-	700 mm	700 mm	27 1/2"	27 1/2"
<b>VOLKSWAGEN Routan</b> , 5-dr Minivan, *09-	700 mm	700 mm	27 1/2"	27 1/2"

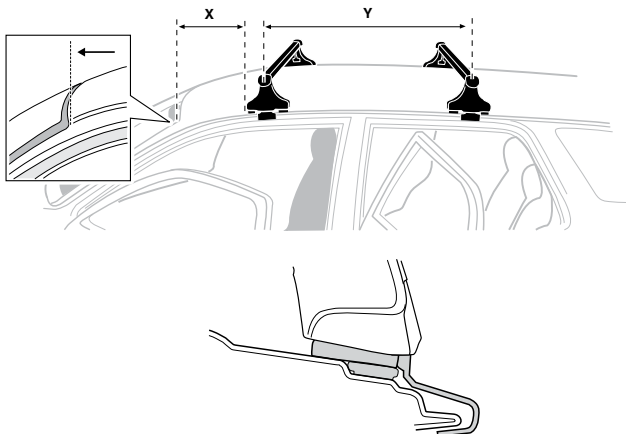

7



**GB/US** Tighten alternately  
**D** Die Schrauben abwechselnd anziehen  
**F** Serrer alternativement chaque côté  
**NL** Afwisselend aan de linker- en de rechterkant aandraaien  
**I** Alternare il serraggio delle viti  
**E** Apertar alternativamente  
**PT** Aperte alternadamente  
**S** Dra åt växelvis  
**FIN** Kierrä vuorotellen  
**EST** Pinguldage vaheldumisi  
**LAT** Pieļieciet pamišus  
**LIT** Užsukinėkite pakaitomis  
**PL** Śruby dokręcaj naprzemiennie  
**RU** Затягивайте попеременно

**CZ** Pokręťta bagażnika dokręcaj naprzemiennie.  
**SK** Dofahajte striedavo  
**SLO** Privijajte izmenično.  
**HR** Naizmjenočno zategnite  
**HU** Egymástól függetlenül szorítandó  
**GR** Σφιγίγες εναλλάξ  
**TR** Dönüşümlü sıkın

**中文** 交替拧紧

**한국어** 번갈아 가며 조이십시오.

**日本語** 交互に締め付けてください。

**ไทย** ชันในแบบสลับ

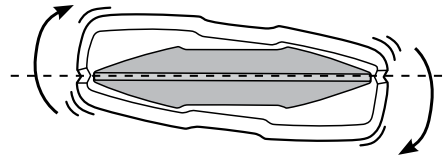
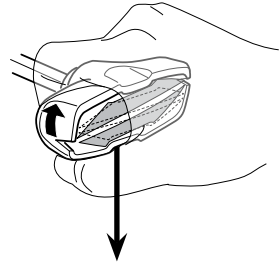
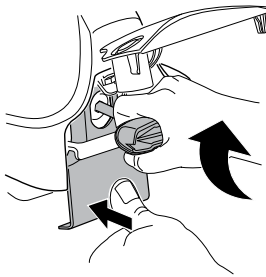
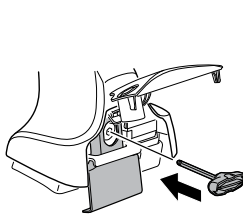

≈ 3 Nm

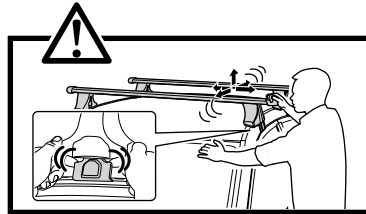
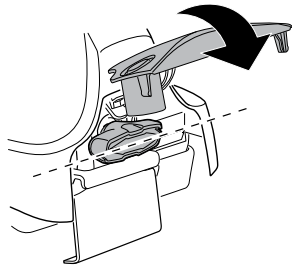

8



x1  
17 mm

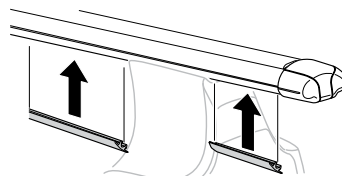
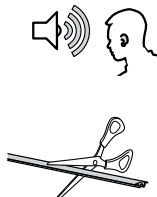

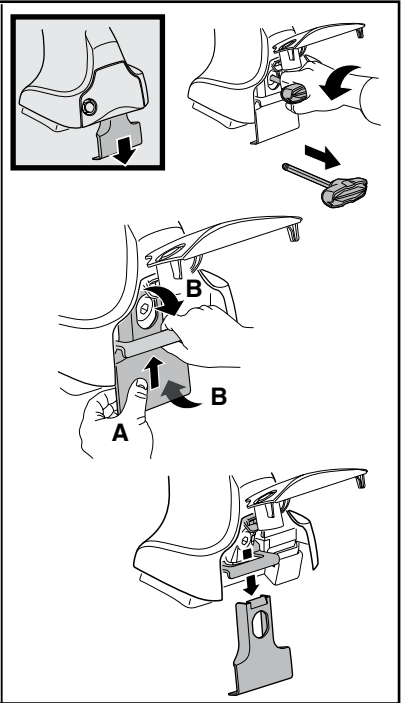
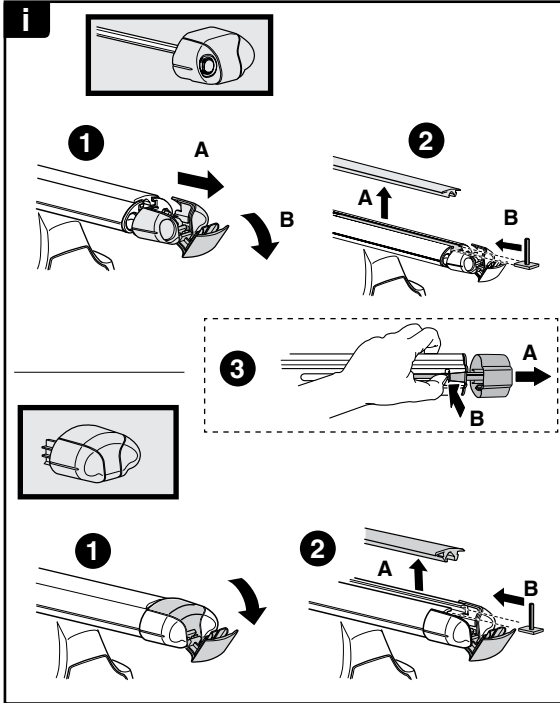

**THULE**  
SWEDEN  
**ONE  
KEY  
SYSTEM**

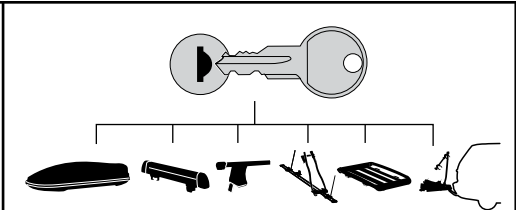

		(x4)
		(x6)
		(x8)
NA		(x10)
EUR		(x12)
ASIA		



WW ▶ Thule Sweden AB, Box 69, 330 33 Hillerstorp, SWEDEN  
NA ▶ Thule Inc., 42 Silvermine Road, Seymour, Connecticut 06483, USA

info@thule.com  
customer.service@thule.com

www.thule.com