

Kit 1015

BMW 3-Series, 2-dr Coupé, 92-98 / *92-99

*North America

480R
754

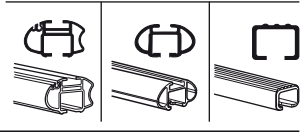
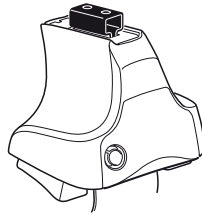

480

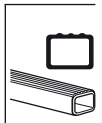
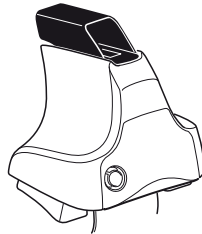

750

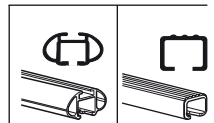
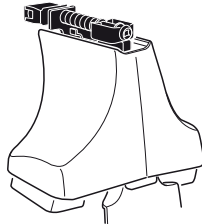

x2 x2 x2 x4	x2	x2 x2 x4 x4	x2 x2	x2

11 x 4

10 x 4

x 1

Kit



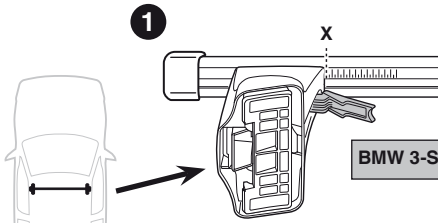

1	X
BMW 3-Series, 2-dr Coupé, 92-98 / *92-99	29,5

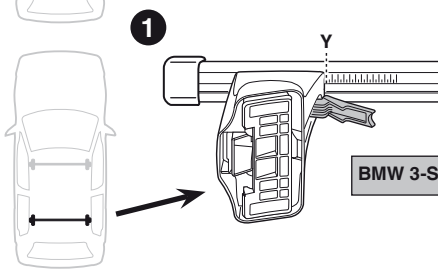

1	Y
BMW 3-Series, 2-dr Coupé, 92-98 / *92-99	26,5

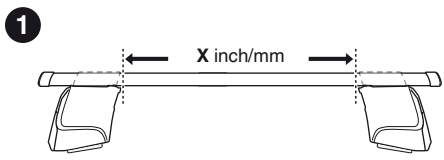
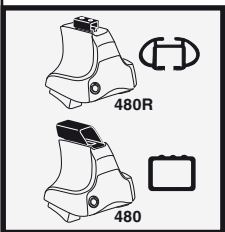
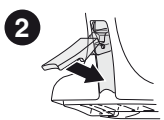

1	X inch	X mm
BMW 3-Series, 2-dr Coupé, 92-98 / *92-99	37 1/4"	946 mm

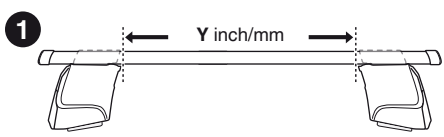
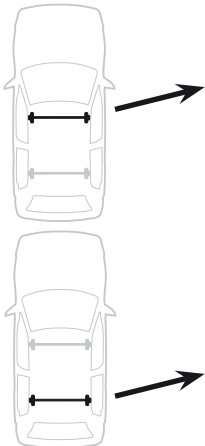
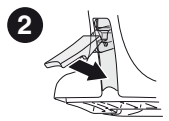

1	Y inch	Y mm
BMW 3-Series, 2-dr Coupé, 92-98 / *92-99	36 1/8"	916 mm



4

BMW 3-Series, 2-dr Coupé, 92-98 / *92-99

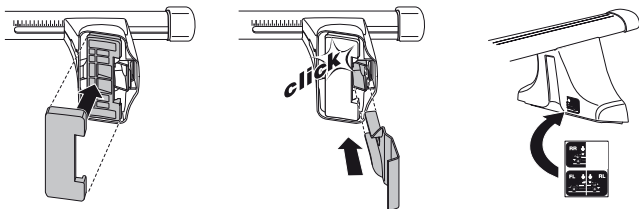
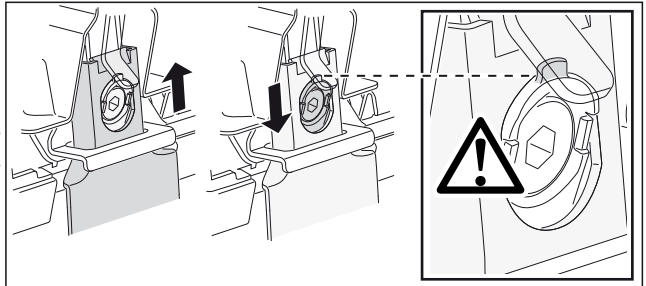
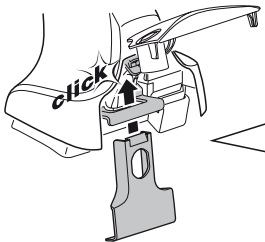
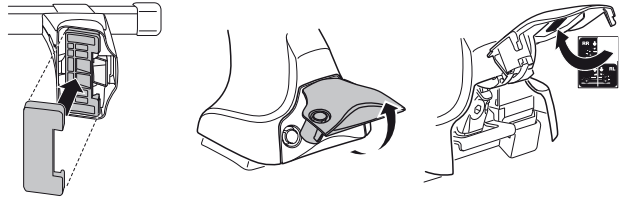
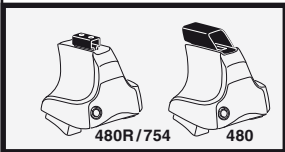
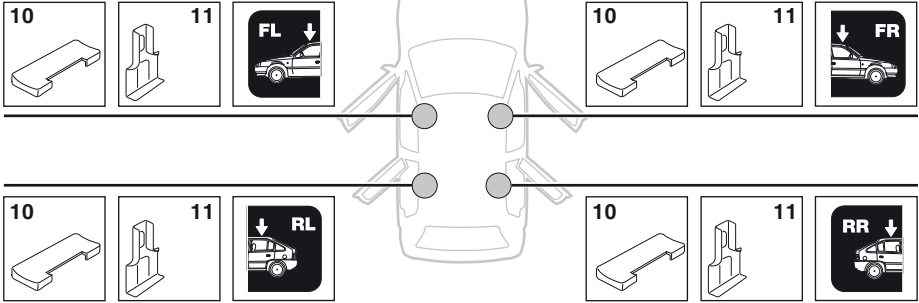

5



	X mm	Y mm	X inch	Y inch
BMW 3-Series, 2-dr Coupé, 92-98 / *92-99	250 mm	700 mm	9 7/8"	27 1/2"

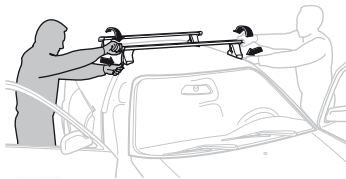
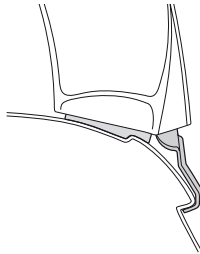
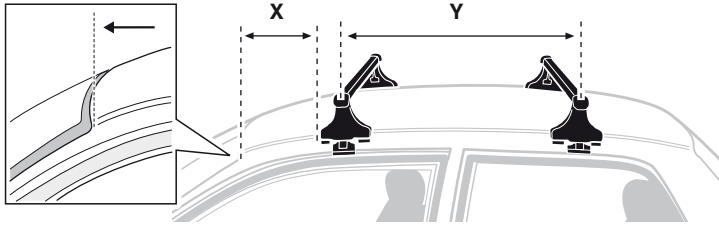

GB/US Tighten alternately

D Die Schrauben abwechselnd anziehen

F Serrer alternativement chaque côté

NL Afwisselend aan de linker- en de rechterkant aandraaien

I Alternare il serraggio delle viti

E Serrare alternativamente

PT Aperte alternadamente

S Dra åt växelvis

FIN Kierrä vuorotellen

EST Pinguldage vaheldumisi

LAT Pielieciet pamišus

LIT Užsukinėkite pakaitomis

PL Śruby dokręcaj naprzemiennie

RU Затягивайте попеременно

CZ Pokręťta багаžníka dokręcaj dokręcaj naprzemiennie.

SK Doťahujte striedavo

SLO Privijajte izmenično.

HR Naizmjenično zategnite

HU Egymástól függetlenül szorítandó

GR Σφιγγετε εναλλάξ

TR Dönüşümlü sıkın

中文 交替拧紧

한국어 번갈아 가며 조이십시오.

日本語 交互に締め付けてください。

ไทย ชันโนแบบสลับ

6



480R/754



480

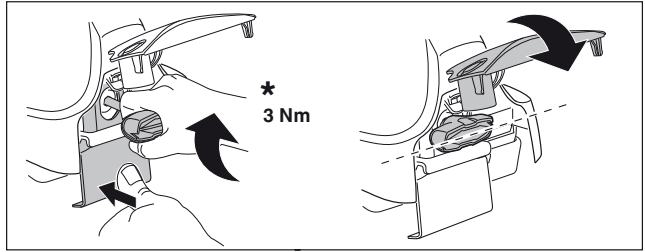
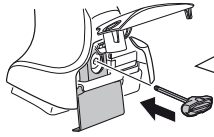

*
3 Nm



*

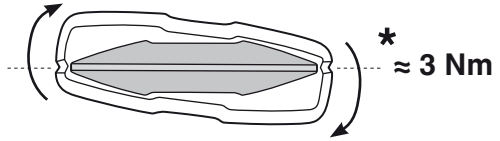

*
≈ 3 Nm

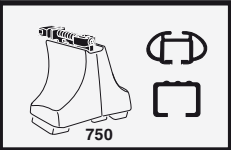
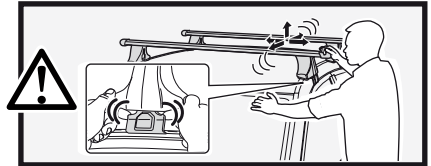

750

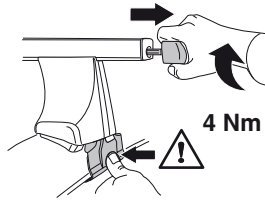

4 Nm

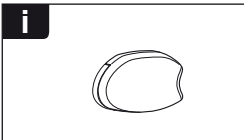
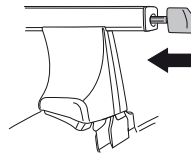

i

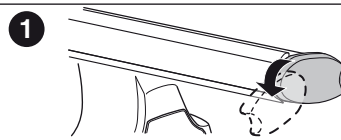

1

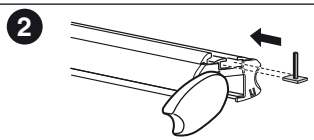

2

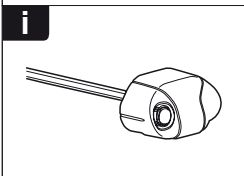

i

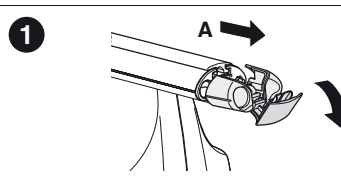

1

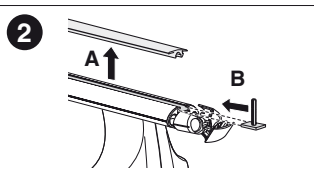

2

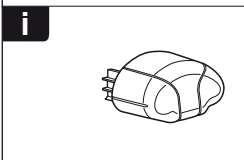

i

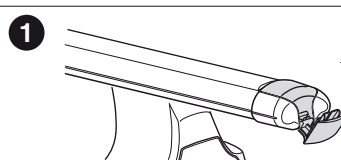

1

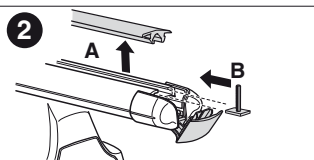

2



THULE
SWEDEN
**ONE
KEY
SYSTEM**



		(x4)
		(x6)
		(x8)
NA		(x10)
EUR		(x12)
ASIA		(x12)



WW ▶ Thule Sweden AB, Box 69, 330 33 Hillerstorp, SWEDEN
NA ▶ Thule Inc., 42 Silvermine Road, Seymour, Connecticut 06483, USA

info@thule.com
customer.service@thule.com

www.thule.com